 AFL Telecommunications GmbH	Type Test Report	No. TB 2118/11 Date: 05.05.2011 Page: 1
--	-------------------------	---

Type test report of OPGW

PROJECT: ASAMCO 10831208/00
Saudi Arabia

PRODUCT: ASLH-D(S)B 36 SMF (A20SA 37 – 2,9)
ASLH-D(S)B 36 NZDSF (A20SA 37 – 2,9)

Specification: TK 10471/10-03/04

SUPPLIER: AFL Telecommunications GmbH



MR. MOODY <small>Quality Management</small>	
<input type="checkbox"/>	Reviewed
<input checked="" type="checkbox"/>	Approved
Date: 26.04 - 05.05.11 TE - 0039	





AFL Telecommunications GmbH

Type Test Report

No. TB 2118/11
Date: 05.05.2011
Page: 2

Data sheet ASLH-D(S)B 36 SMF (A20SA 37 - 2,9)



A Future Business

ASLH-D(S)B 36 SMF (A20SA 37 - 2,9)

Critical Ground Wire (CGW)

according to EN 60754-4 standard



- Breaking location of cable jacket, right and left strands
- Mass acc. to EN 60754
- Maximum fire capacity per km to EN 60754
- Fumes evolved acc. to EN 60754-4 system 0.5% = 550
- Fumes acc. to EN 60754
- Capacity acc. to EN 60754-4 with 210°C/30min

Configuration

Conductor	1 Stainless Steel Tube with 10 SMF Stranded steel tube material DIN EN 10273-02 size 10 x 1.40	2 50 x 3.60 mm
Layer 1	7 A20SA - Wires	2.60 mm

Mechanical Data

Cable Diameter	8.8 mm
Cable Weight	375 kg/km
Supporting Cross Section	37.2 mm ²
Rated Tensile Strength (RTS)	67.3 kN
Rate RTS (Cable Weight)	17.5 km
Modulus of Elasticity	162.0 kN/mm ²
Thermal Elongation Coefficient	13.0 10 ⁻⁶ /K
Permissible Maximum Working Stress (62% RTS)	530.7 N/mm ² (7.6 kN)
Recommended Freelay Stress (16% RTS)	200.7 N/mm ² (7.6 kN)
Ultimate Exceptional Stress (77% RTS)	916.8 N/mm ² (30.1 kN)

Electrical Data

DC Resistance (D.C.)	2.35 Ohm/km
Conductivity	20.0% IACS
Short Time Current (10s. 60-200°C)	2.8 kA
Short Time Current (10s. 60-200°C)	5.3 kA
Short Time Current Capacity (150-200°C)	6.3 kA ² s

Application

Maximum Permissible Installation Force	16.2 kN
Minimum Bending Radius	static: 108 mm dynamic: 129 mm
Normal Delivery Length	6000 m
Temperature Range	Installation: -10 to +50 °C Operation and Operation: -40 to +80 °C

Заличено по чл. 36а, ал.3 от ЗОП



AFL Telecommunications GmbH

Type Test Report

No. TB 2118/11
Date: 05.05.2011
Page: 3

Data sheet ASLH-D(S)B 36 NZDSF (A20SA 37 – 2,9)



A Fullkura Business

ASLH-D(S)B 36 NZDSF (A20SA 37 – 2,9)

Optical Ground Wire (OPGW)

Optical Ground Wire (OPGW)

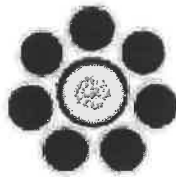

- Stranding direction of outer layer: right hand (Z-stranding)
- Wires according to EN 60228
- Maximum fibre capacity per strand: 12
- Fibres according to ITU-T G.652 system (B1.1/B2C)
- Fibres according to G.655
- Integrated wooden drum with protection

Cable Construction

Center	1 Strand in steel tube with 12 fibres Standard fibre type number ITU-T G.652 B2C (A20SA 37)	2.90 ± 0.40 mm
Layer 1	7 A20SA - Wires	2.60 mm

Mechanical Data

Cable Diameter	8.8 mm
Cable Weight	275 kg/km
Supporting Cross Section	57.2 mm ²
Rated Tensile Strength (RTS)	47.3 kN
Ratio RTS / Cable Weight	17.5 km
Modulus of Elasticity	162.0 kN/mm ²
Thermal Expansion Coefficient	13.0 10 ⁻⁶ /K
Permissible Maximum Working Stress (40% RTS)	536.7 N/mm ² (19.0 MPa)
Recommended Everyday Stress (10% RTS)	209.7 N/mm ² (7.6 MPa)
Ultimate Exceptional Stress (12% RTS)	816.6 N/mm ² (30.1 MPa)

Electrical Data

DC Resistance (10°C)	2.05 Ohm/km
Conductivity	20.0% IACS
Short Time Current (10% 50-200°C)	2.8 kA
Short Time Current (10% 50-200°C)	5.1 kA
Short Time Current Capacity (10% 50-200°C)	6.3 kA's

Application

Maximum Permissible Installation Force	16.2 kN
Minimum Bending Radius	static: 108 mm dynamic: 128 mm
Normal Delivery Length	5000 m
Temperature Range	Installation: -10 to +50 °C Transportation and Operation: -40 to +80 °C

Залічено по чл. 36а, ал.3 от ЗОП

3

Summary of results

Item	Inspection item	Test procedure	Criteria of acceptance	Result	Test Report Annex
1	Cable Cutoff Wavelength Test	IEC 60793-1-44 10-TMSS-04, rev. 0; 5.1.1a	$\lambda_{cc} \leq 1450\text{nm}$ for G655 $\lambda_{cc} \leq 1260\text{nm}$ for G652	1027 nm 1210 nm	1a,b
2	Fluid Penetration Test	IEC 60794-1-2-F5 10-TMSS-04, rev. 0; 5.1.1b	no water leakage	no water leakage	2
3	Compound -Flow (Drip) Test	IEC 60794-1-2-E14 10-TMSS-04, rev. 0; 5.1.1c	no drip at 65°C	no drip	3
4	Short Circuit Test	IEC 60794-1-2-H1 10-TMSS-04, rev. 0; 5.1.1d	increase of att. 1550nm $\leq 1,0$ dB/km; no damage of cable components	see test report of RWE laboratory	4
5	Sheave Test	IEC 60794-1-2-E18 10-TMSS-04, rev. 0; 5.1.1f	increase of att. 1550nm $\leq 1,0$ dB/km; no damage of cable components; deformation $\leq 0,5\text{mm}$	increase of att. 1550nm 0,00 dB/km; no damage of cable components; no deformation after test (0,0mm)	5
6	Crush Test	IEC 60794-1-2-E3 (1kN) 10-TMSS-04, rev. 0; 5.1.1g	increase of att. 1550nm $\leq 0,1$ dB/fiber	increase of att. 1550nm 0,00 dB/fiber	6
7	Impact Test	IEC 60794-1-2-E4 (3Nm) 10-TMSS-04, rev. 0; 5.1.1g	increase of att. 1550nm $\leq 0,1$ dB/fiber	increase of att. 1550nm 0,00 dB/fiber	7
8	Stress-Strain Test/Rated Strength Test	IEEE 1138 10-TMSS-04, rev. 0; 5.1.1i,k	change of attenuation after test $\leq 0,2$ dB/km; breaking strength $\geq 90\%$ RTS	change of attenuation after test $\leq 0,01$ dB/km; breaking strength $> 100\%$ RTS	8

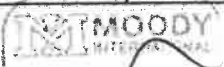
 Reviewed
 Witnessed
 Date: 05.05.11

Заличено по чл. 36а, ал.3 от ЗОП

3

 AFL - Electromechanicals Limited	<h2>Type Test Report</h2>	No. TB 2118/11 Date: 05.05.2011 Page: 5
---	---------------------------	---

Item	Inspection item	Test procedure	Criteria of acceptance	Result	Test Report Annex
9	Temperature Cycling Test (-45°C/+85°C)	IEC 60794-1-2-F1 10-TMSS-04. rev. 0: 5.1.1j	increase of att. 1550nm $\leq 0,2$ dB/km	increase of att. 1550nm $\leq 0,014$ dB/km	9
10	Aeolian Vibration Test	IEC 60794-1-2 annex C	increase of att. 1550nm $\leq 1,0$ dB/test fibre km; no damage of cable components	increase of att. 1550nm $\leq 0,01$ dB/test fibre km; no damage of cable components	10
11	Creep Test	IEC 61395 (30% RTS; 1000h)	record of strain vs. time	as per report from RIBE	11
12	Salt Spray (Corrosion resistant) Test (1000h/35°C/5% Salt)	EIA/TIA-455-16A	-	as per report from RIBE	12



Заличено по чл. 36а, ал.3 от ЗОП

✓



AFL Telecommunications GmbH

Type Test Report

No. TB 2118/11
Date: 05.05.2011
Page: 6

Cable Cutoff Wavelength Test

Annex 1a

Cable type: ASLH-D(S)B 36 SMF (A20SA 37 - 2,9)
Cable product spec.: TK 10471/10-03
Cable-ID: 10283527/6735
Test procedure: IEC 60793-1-44,

Measurement devices: spectral measurement system

Test conditions: sample : 20m cabled fibre + 1m exposed
at both ends
wavelength-range: 850 - 1500nm
number of fibres: 1 representative fiber

Requirements: Cut off wavelength $\lambda_{cc} \leq 1260\text{nm}$ for G.652

Results from fiber supplier: 1210 nm

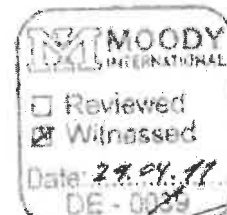

Заличено по чл. 36а, ал.3 от ЗОП

Handwritten signature

29.4.11

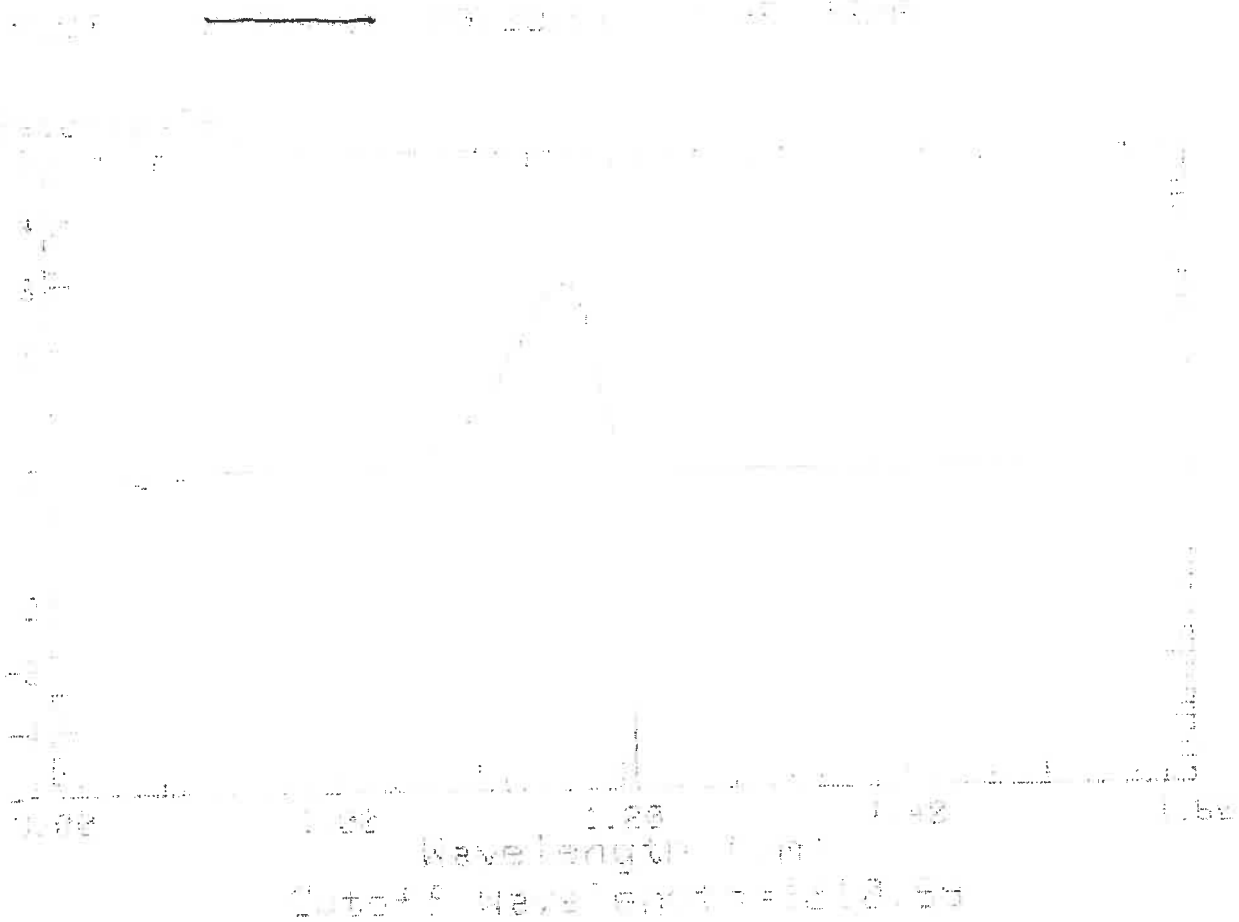

Handwritten signature



MOODY
INTERNATIONAL
 Reviewed
 Witnessed
Date: 29.04.11
DE-0089

Заличено по чл. 36а, ал.3 от ЗОП



AFL Telecommunications GmbH

Type Test Report

No. TB 2118/11
Date: 05.05.2011
Page: 7

Cable Cutoff Wavelength Test

Annex 1b

Cable type: ASLH-D(S)B 36 NZDSF (A20SA 37 - 2,9)
Cable product spec.: TK 10471/10-04
Cable-ID: 10283392/6547
Test procedure: IEC 60793-1-44, method B

Measurement devices: spectral measurement system

Test conditions: sample : 20m cabled fibre + 1m exposed
at both ends
wavelength-range: 850 - 1500nm
number of fibres: 1 representative fiber

Requirements: Cut off wavelength $\lambda_{cc} \leq 1450\text{nm}$ for G.655

Results from fiber supplier: 1027 nm

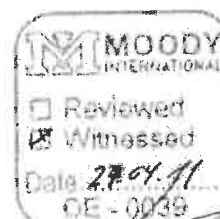

Заличено по чл. 36а, ал.3 от ЗОП

✓

27.4.11

2011
2011

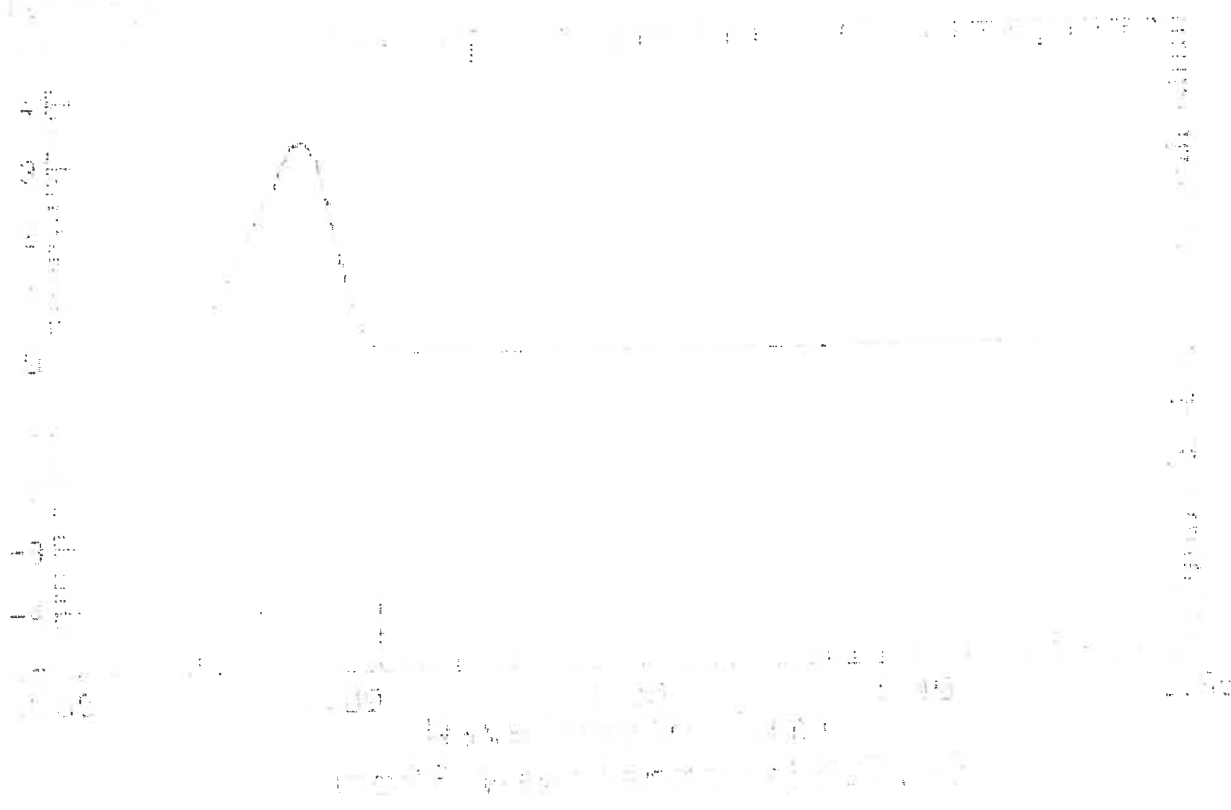

Handwritten signature or scribble.



M MOODY
INTERNATIONAL
 Reviewed
 Witnessed
Date: 27.04.11
DE-0039

Заличено по чл. 36а, ал.3 от ЗОП

✓

3

 AFL Telecommunications GmbH	Type Test Report	No. TB 2118/11 Date: 05.05.2011 Page: 8
--	-------------------------	---

Fluid Penetration Test		Annex 2
Cable type: Cable product spec.: Cable-ID: Test procedure:	ASLH-D(S)B 36 SMF (A20SA 37 – 2,9) TK 10471/10-03 10283527/6735 IEC 60794-1-2-F5	
Measurement devices: Water proof test stand-		
Test conditions:	sample length: 3m+1m height of water: 1m test time: 24h test conducted only for tubes	
Requirements:	no water leakage	
Results:	no water leakage	



Заличено по чл. 36а, ал.3 от ЗОП

2

 AFL Telecommunications GmbH	Type Test Report	No. TB 2118/11 Date: 05.05.2011 Page: 9
--	-------------------------	---

Compound –Flow (Drip) Test		Annex 3
Cable type:	ASLH-D(S)B 36 SMF (A20SA 37 – 2,9)	
Cable product spec.:	TK 10471/10-03	
Cable-ID:	10283527/6735	
Test procedure:	IEC 60794-1-2-F5	
Measurement devices: air oven		
Test conditions:	sample length:	0,3m
	number of samples:	5
	test temperature:	65°C
	test time:	24h
Requirements:	no drip at 65°C	
Results:	no drip	



M MOODY INTERNATIONAL
<input type="checkbox"/> Reviewed
<input checked="" type="checkbox"/> Witnessed
Date: 26.07.04.11
DE-0035

Заличено по чл. 36а, ал.3 от ЗОП

8

Test Setup

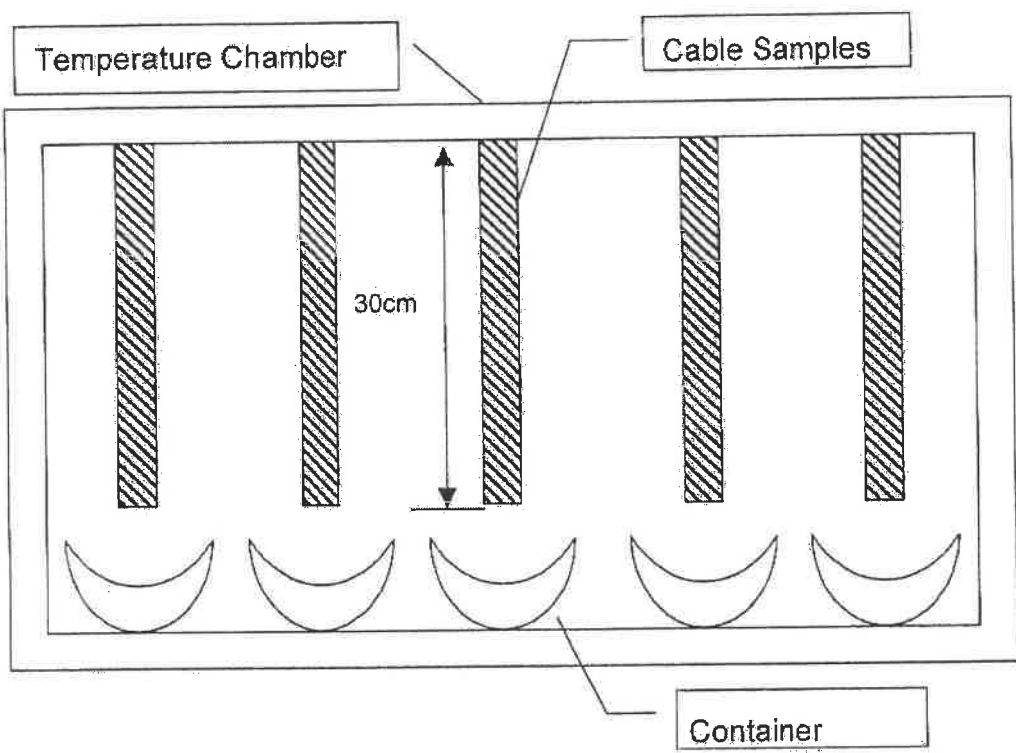

MOODY
INTERNATIONAL
 Reviewed
 Witnessed
Date: 26.05.2011
05.0038

Заличено по чл. 36а, ал.3 от ЗОП

J



AFL Telecommunications GmbH

Type Test Report

No. TB 2118/11
Date: 05.05.2011
Page: 11

Short Circuit Test

Annex 4

Cable type: ASLH-D(S)B 36 SMF (A20SA 37 – 2,9)
Cable product spec.: TK 10471/10-03
Cable-ID: 10283527/6735
Test procedure: IEC 60794-1-2-H1

Measurement devices: Stabilised light source
Optical Power Meter
OTDR
Short circuit test laboratory as described in the attached report

Test conditions: length under test: min. 10m
optical length: min. 100m
fibres in a loop: min. 10
wavelength: 1550nm
test load: 15+/-5% RTS
short-circuit current/test duration: 1,0s/2,9 kA equivalent to 8,3 MA²s
number of pulses: min. 2

Requirements: increase of att. 1550nm \leq 1,0 dB/km
no damage of cable components

Results: see test report of independent laboratory

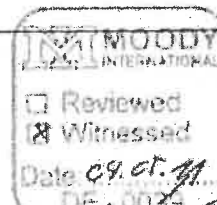

Заличено по чл. 36а, ал.3 от ЗОП

Note:

Hereby we confirm that the OPGW ASLH – D(S)b 36 SMF (A20SA 37 – 2,9) manufactured by AFL Telecommunications GmbH **passed** the short circuit tests according to IEC 60794-1-2:2003; test procedure H1 at the RWE Eurotest laboratory.

Test parameter:

The conductor temperature before the short circuits was 50 °C.

Test	I_k [kA]	Duration [ms]	I^2t [MA ² s]	Max. Temp. [°C]
1	2.92	1002	8.52	211.2
2	2.93	1000	8.57	209.2
3	2.92	1000	8.53	208.8

Table 1: Parameters of the short circuit tests

The optical attenuation was not influenced by the short-circuit stress. No damage was visible at the conductor after the tests.

Заличено по чл. 36а, ал.3 от ЗОП

Dipl.-Ing. Walter

(Test engineer)

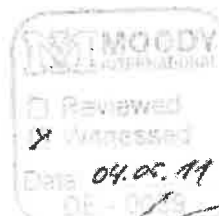

Заличено по чл. 36а, ал.3 от ЗОП

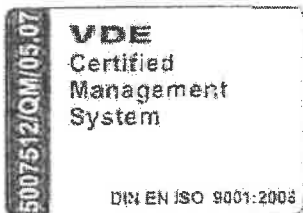

RWE Eurotest GmbH Electrotechnical Testing Laboratory

RWE

Test report

No.: 11_107

Version: 2/2

Customer : AFL Telecommunications GmbH
Bonnenbroicher Straße 2-14
41048 Mönchengladbach

Test object : Optical Ground Wire (OPGW)

Type : ASLH-D(S)b 36 SMF (A20SA 37 - 2,9)

Manufacturer : AFL Telecommunications GmbH

Date of receipt : 04.05.2011

Date of test : 04.05.2011

Applied test regulations : According to IEC 60794-1-2:2003; test procedure H1

Test carried out : Short circuit tests

Test result : The OPGW type ASLH-D(S)b 36 SMF (A20SA 37 - 2,9) manufactured by AFL Telecommunications GmbH passed the short circuit tests according to IEC 60794-1-2:2003; test procedure H1

Specialist testers : A. Cichowski; C. Pieper; H. Walter

Dortmund, 05.05.2011

D. Borneburg
Manager test laboratory

H. Walter
Test engineer

Заличено по чл. 36а, ал.3 от ЗОП

Report No. 11_107 contains 9 pages and 3 annexes.

Test results in this report are only valid for the tested objects. A partly duplication or publication is not allowed without written permission by RWE Eurotest. The authenticity of this report is only ensured with RWE-coinage on the first page.

Summary

RWE Eurotest GmbH carried out a short circuit test according to IEC 60794-1-2; test procedure H1 on an OPGW manufactured by AFL Telecommunications GmbH, type ASLH-D(S)b 36 SMF (A20SA 37 - 2,9). The optical attenuation of the optical fibres was measured by the manufacturer during the tests. The recording of this measurement was carried out by RWE Eurotest.

The OPGW, type ASLH-D(S)b 36 SMF (A20SA 37 - 2,9) manufactured by AFL Telecommunications GmbH passed the short circuit test according to IEC 60794-1-2; test procedure H1.

Contents:	Page:
1. Applied test regulations	4
2. Technical data of the test object	4
3. Test and measuring equipment	5
4. Tests carried out and results	6

Annex:

01 Temperature-, attenuation-, short circuit current-, tensile load/time diagrams	(9 pages)
02 Data sheet of the OPGW	(1 page)
03 Examination of the test object (OPGW)	(3 pages)

1. Applied test regulations

According to

IEC 60794-1-2:2003; test procedure H1

Optical fibre cables

Part 1-2: Generic specifications – Basic optical cable test procedures

2. Technical data of the test object

Type ASLH-D(S)b 36 SMF (A20SA 37-2,9)	
Cable Diameter	8.6 mm
Supporting Cross Section	37.2 mm ²
Rated Tensile Strength (RTS)	47.3 kN
Nominal Short Circuit Rating	2.9 kA/1.0 s ($I^2t = 8.3 \text{ kA}^2\text{s}$)

Table 1: Technical data of the test object (for details see annex 02).

3. Test and measuring equipment

Equip.-No.	cal.	Equipment	Type	Manufacturer
ET-501	*	Fibre Optic Isolated Digitizing Subsystem	BE 256-M7	Nicolet
ET-505	*	Impulse Current Sensing Resistor	ISM 250 P	Hilo Test
ET-506	*	Impulse Current Sensing Resistor	ISM 250 P	Hilo Test
ET-507	*	Impulse Current Sensing Resistor	ISM 250 P	Hilo Test
ET-533		50 kA High-Current Test Equipment	GDPN 5000/12 Sp	Siemens
ET-651	*	ScopeCorder	DL750	YOKOGAWA
01-107	1)	Optical Power Meter	ML 910 B	Anritsu
01-107a	1)	Optical Power Sensors	MA 9301 A	Anritsu
01-107b	1)	Optical Power Sensors	MA 9301 A	Anritsu
0666	1)	Stabilized Light Source	MG 9001 A	Anritsu
01-111		LED Source	MG 0918 D	Anritsu
-	*	Thermocouples 0.5 mm	NiCr-Ni	Rössel

*) Measuring equipment is calibrated based on national and international reference standards. Calibration certificates can be inspected on request.

Table 2: Test and measuring equipment

The measurement uncertainty of the measuring instruments has been calculated and is archived by RWE Eurotest. Documents can be inspected on request.

4. Tests carried out and results

Short circuit test

A section of about 50 m of the OPGW under test was prepared by the customer and clamped into the test stand shown in figure 1. The OPGW was prepared with a protective spiral and a guy spiral. With a mechanical power drive in connection with a tension meter the wire tension was adjusted to 15 % of the Rated Tensile Strength (RTS) of the wire under test (7.1 kN). For purpose of mechanical damping during the short-circuit test two springs were installed at each end of the mechanical system including the test object (fig. 1).

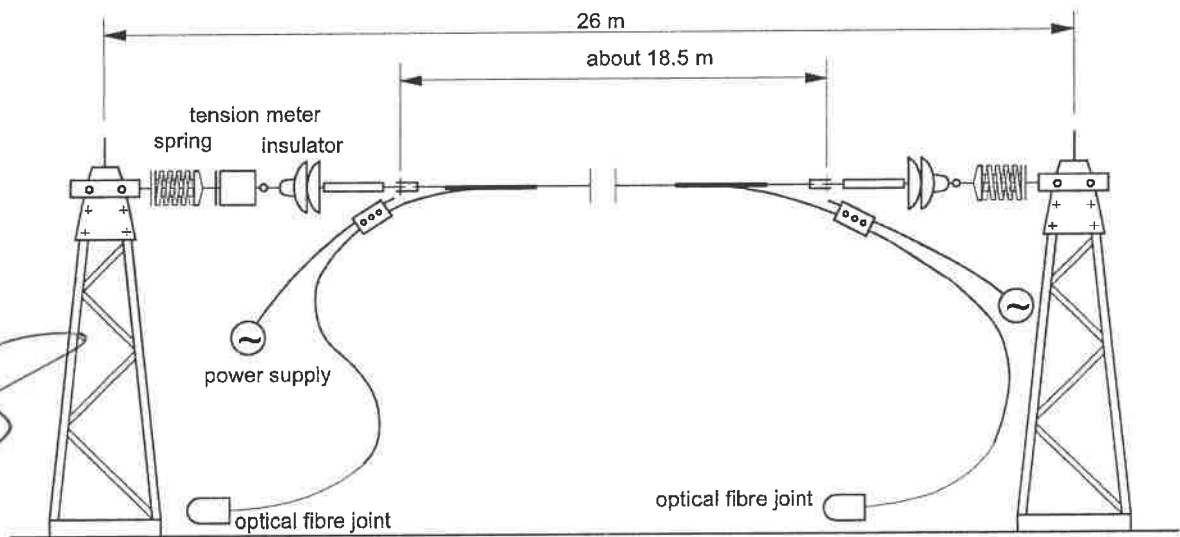

Figure 1: Test arrangement.

Thermometry

The temperature of the wire was measured with NiCr-Ni thermocouples (diameter of 0.5 mm) during the short-circuit test at three points, T2 and T4 100 mm on the left and on the right side of the middle of the test object. They were inserted between the layers of wires of the OPGW (see fig. 2). T3 was on the top in the middle of the test object. T1 measured the ambient temperature.

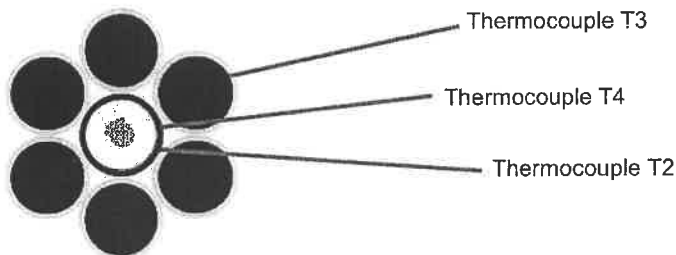

Figure 2: Points of temperature measurement.

Measurement of the optical attenuation

The measurement of the optical attenuation was carried out by the customer. Hereby the optical fibres of the test object were connected in series (36 fibres = about 1800 m).

Continuous recording of the optical attenuation of the fibres was done by RWE Eurotest.

Realization

The following short circuit tests were carried out according to the prescription of the manufacturer:

Short circuit test:	2.9 kA/1.0 s ($I^2t = 8.3 \text{ kA}^2\text{s}$)
Rated tensile strength:	47.3 kN
Tensile load: $47.3 \text{ kN} * 15 \% =$	7.1 kN
Test length:	50 m
Electrically stressed cable length:	20.50 m
Mechanically stressed cable length:	18.50 m
Number of short circuit tests:	3
Temperature before testing:	50 °C

Results of the test

The results of the tests are summarized in table 3 and table 4. The temperature-, attenuation-, short circuit current- and tensile load/time-diagrams are presented in annex 01.

Test	I_k [kA]	Duration [ms]	I^2t [MA ² s]
1	2.92	1000	8.53
2	2.93	1000	8.58
3	2.92	1000	8.53

Table 3: Parameters of the short circuit tests.

Test	Measured temperature between tube and layers				Measured temperature on the top of the OPGW	
	v_0 [°C] T2	v_{max} [°C] T2	v_0 [°C] T4	v_{max} [°C] T4	v_0 [°C] T3	v_{max} [°C] T3
1	51.6	211.1	50.9	205.7	49.3	188.0
2	51.4	209.2	50.9	207.7	49.9	191.6
3	51.7	208.6	50.8	206.2	49.7	190.4
v_0 - temperature before test v_{max} maximum temperature						

Table 4: Results of the temperature measurement.

The optical attenuation was not influenced by the short-circuit stress. No damage was visible at the conductor after the tests.

The OPGW, type ASLH-D(S)b 36 SMF (A20SA 37-2,9) manufactured by AFL Telecommunications GmbH passed the short circuit test according to IEC 60794-1-2; test procedure H1.

Examination of the test object

After the short-circuit test 3 samples, each 1 m long, were cut out of the test object for examination.

- Sample 1 left side of the test object
- Sample 2 middle of the test object
- Sample 3 right side of the test object

Results of the Examination:

No damage was visible at the wires, the tube and the optical fibres. A photo documentation of the examination is given in annex 03.

- End of report -

3

Short circuit tests

Test 1

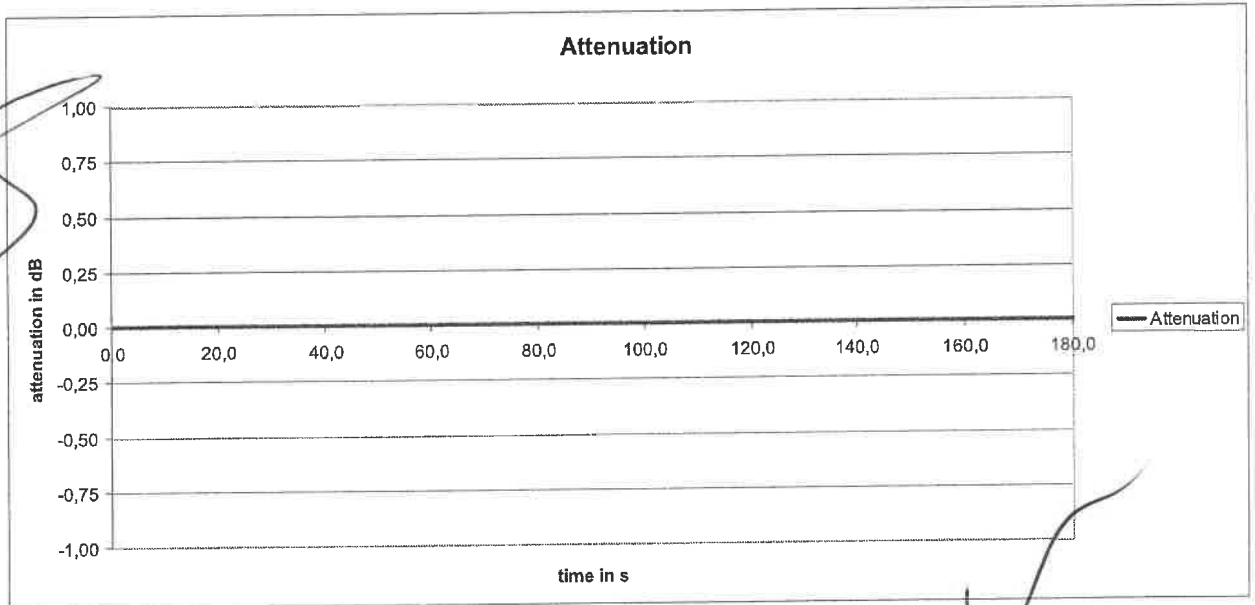
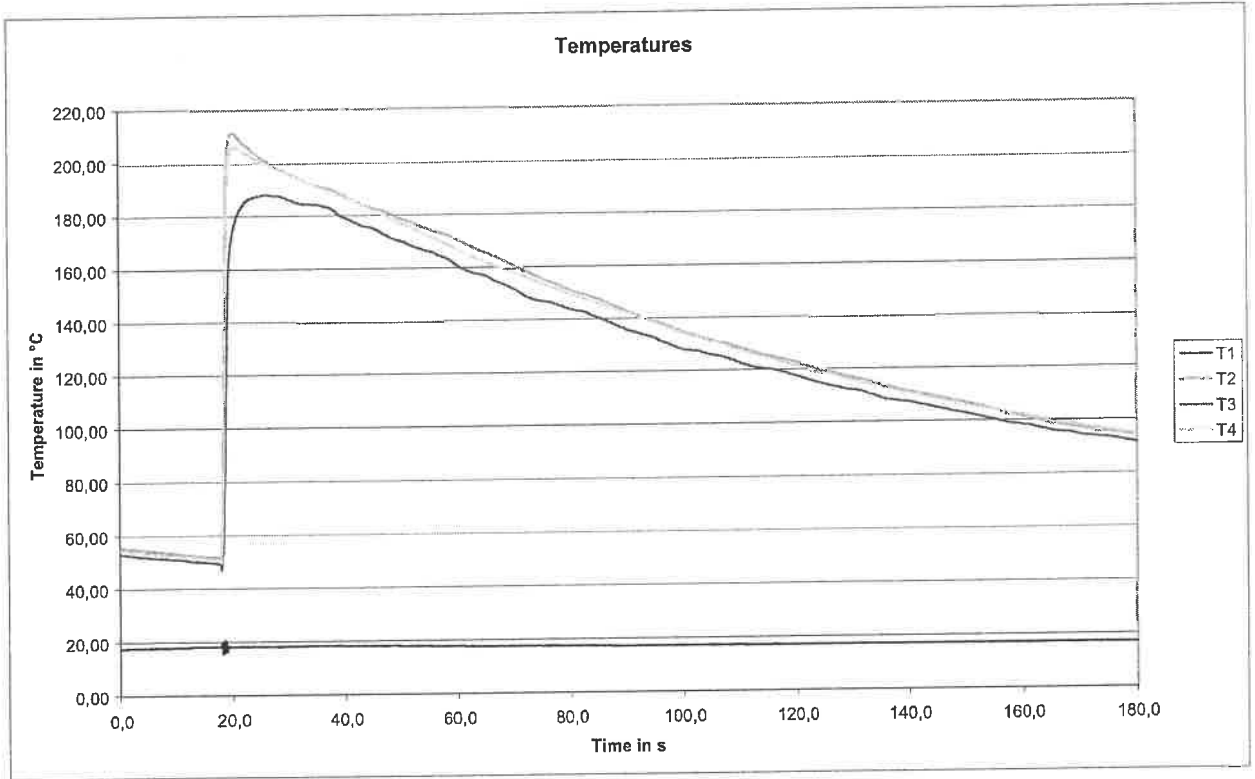

Test 1

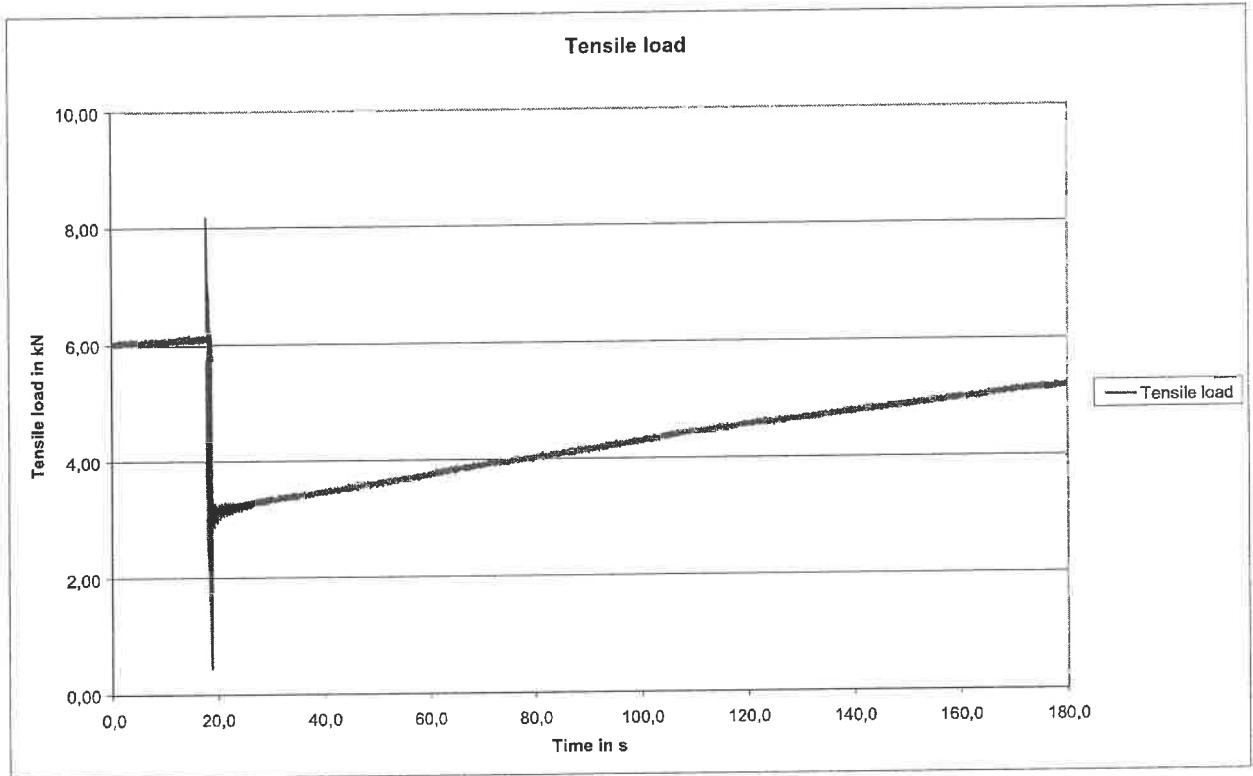

Short circuit current

Test-No.: 11_107

Test 1

04.05.2011

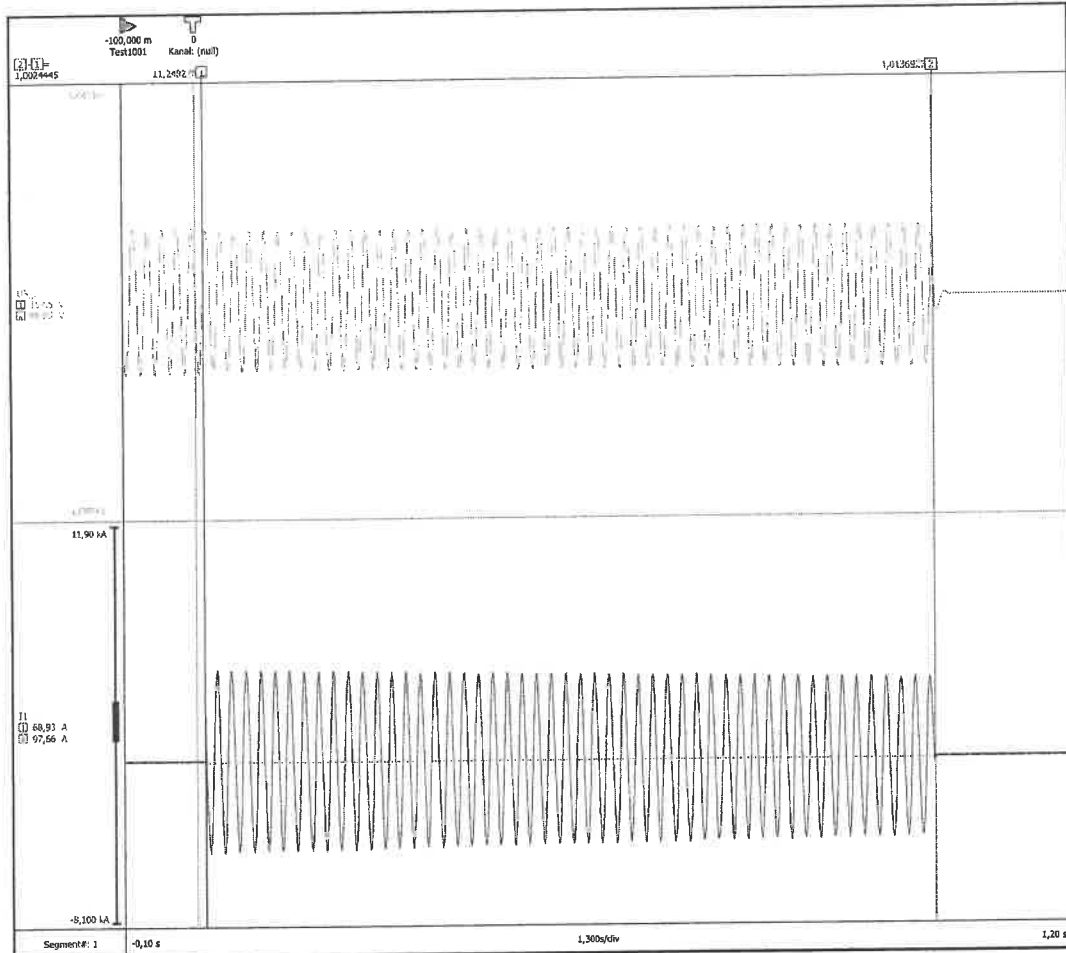

Table

U1 2 eff	237.7	V
U3 1 eff	230.2	V
I1 eff	2.915 k	A
I3 eff	2.890 k	A
I1 ^{2t}	8.520 M	A ² s
I3 ^{2t}	8.370 M	A ² s
I1 max	-11.04 k	A
I3 max	-10.11 k	A
Time	1.002	s
Winkel cursor	18.04 k	°
Strom im Mittel	2.902 k	A
Winkel im Mittel	25.20	°
LeerSpg	238.4	V

Settings of the high current plant

	L1	L3
U [V]	412	412
R _{slide} [mΩ]	0,5	0,5
R _{fixed} [mΩ]	35	25
X _L	i	i

Test 2

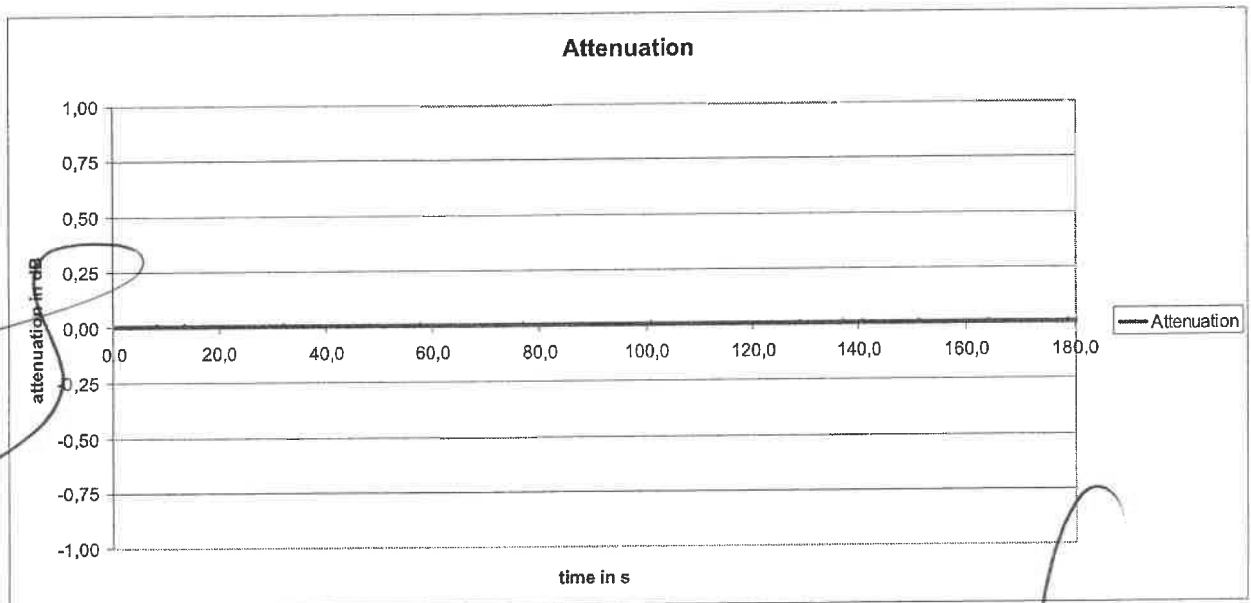
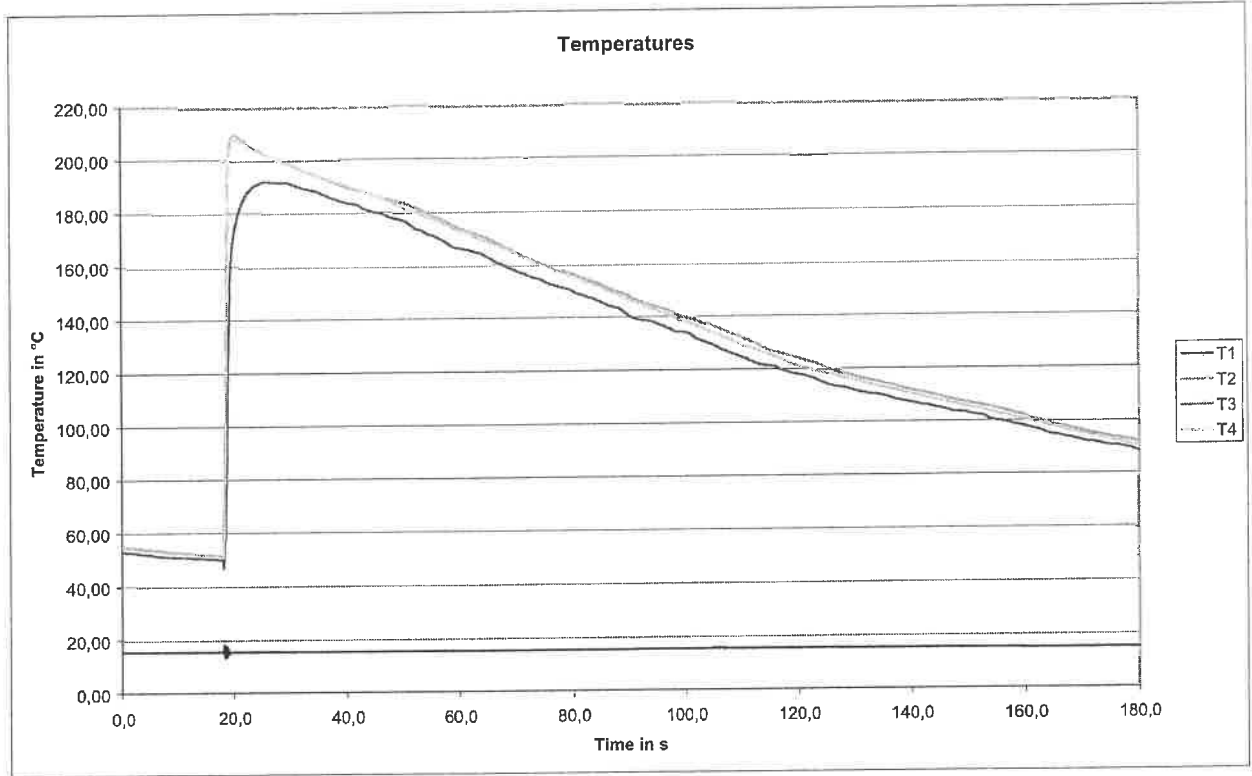

Test 2

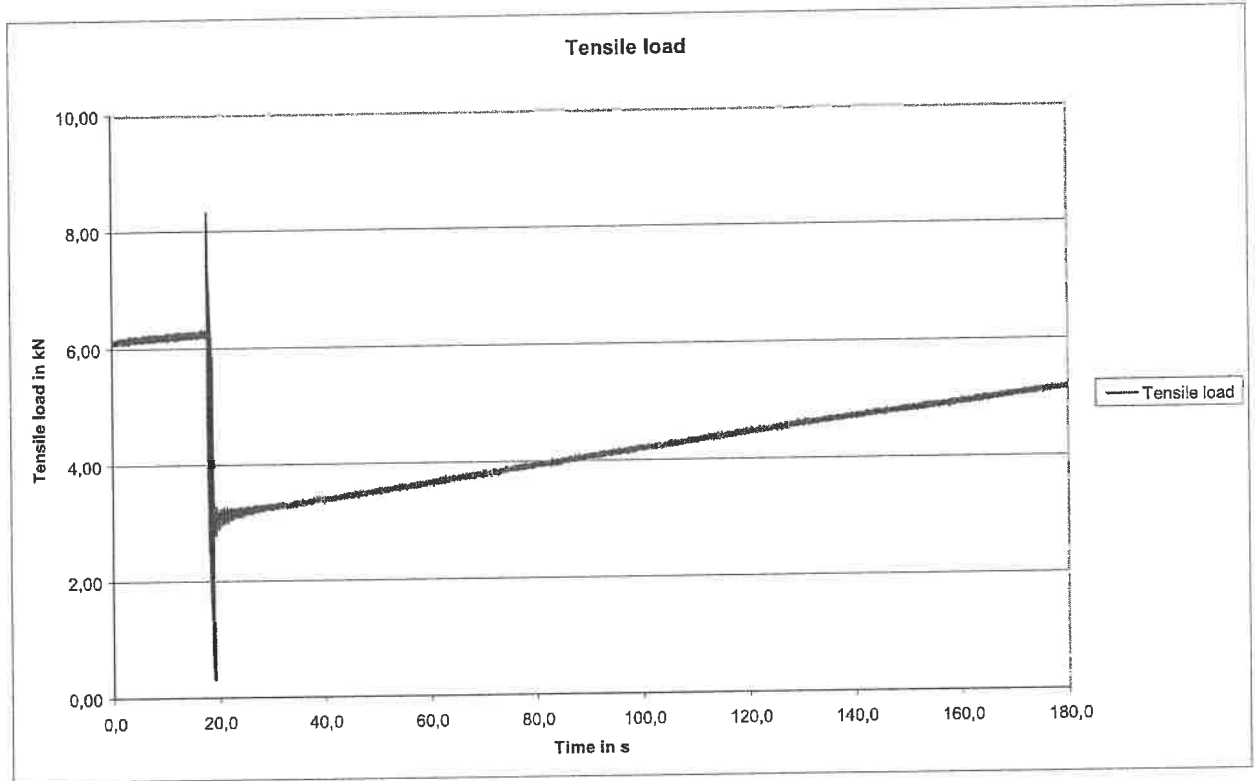

Short circuit current

Test-No.: 11_107

Test 2

04.05.2011

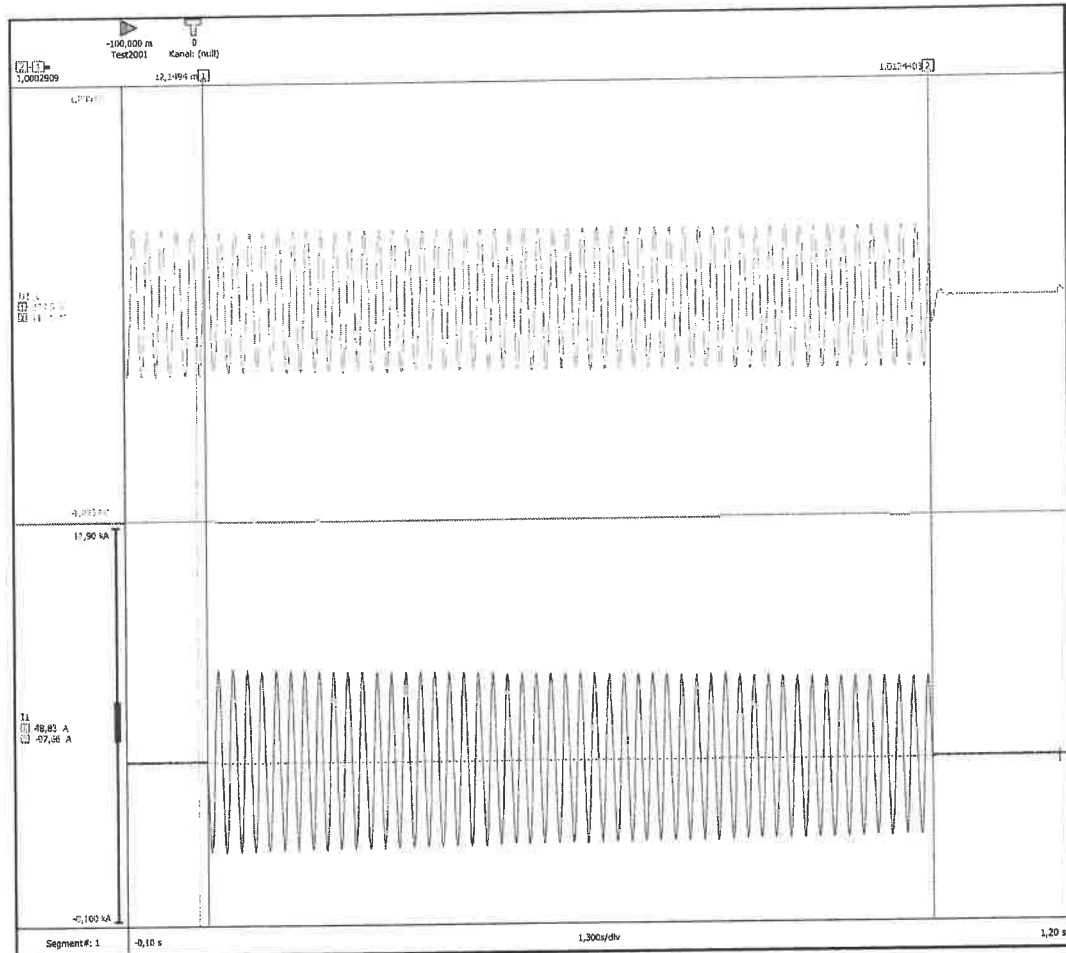

Table

U1 2 eff	238,2	V
U3 1 eff	230,5	V
I1 eff	2,927 k	A
I3 eff	2,902 k	A
I1 ^{2t}	8,568 M	A ² s
I3 ^{2t}	8,425 M	A ² s
I1 max	-11,38 k	A
I3 max	-18,46 k	A
Time	1,000	s
Winkel cursor	18,01 k	°
Strom im Mittel	2,914 k	A
Winkel im Mittel	25,02	°
LeerSpg	238,9	V

Settings of the high current plant

	L1	L3
U [V]	412	412
R _{slide} [mΩ]	0,5	0,5
R _{fixed} [mΩ]	35	25
X _l	i	i



Test 3

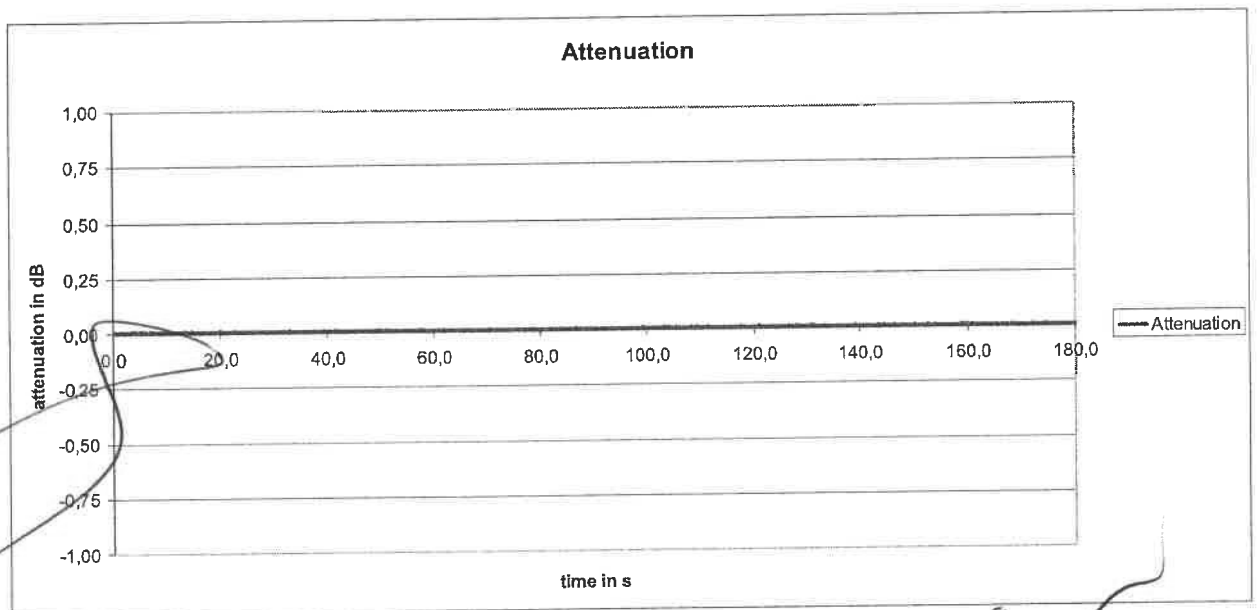
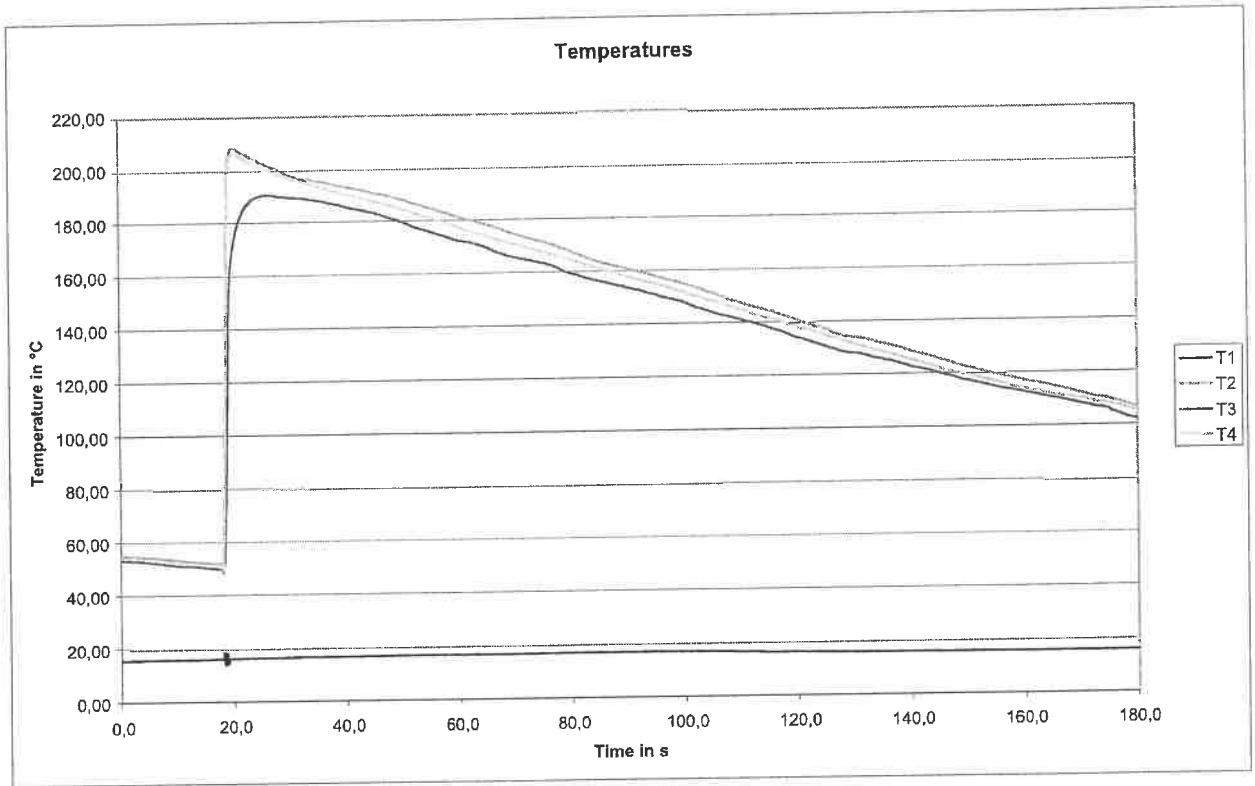

Test 3

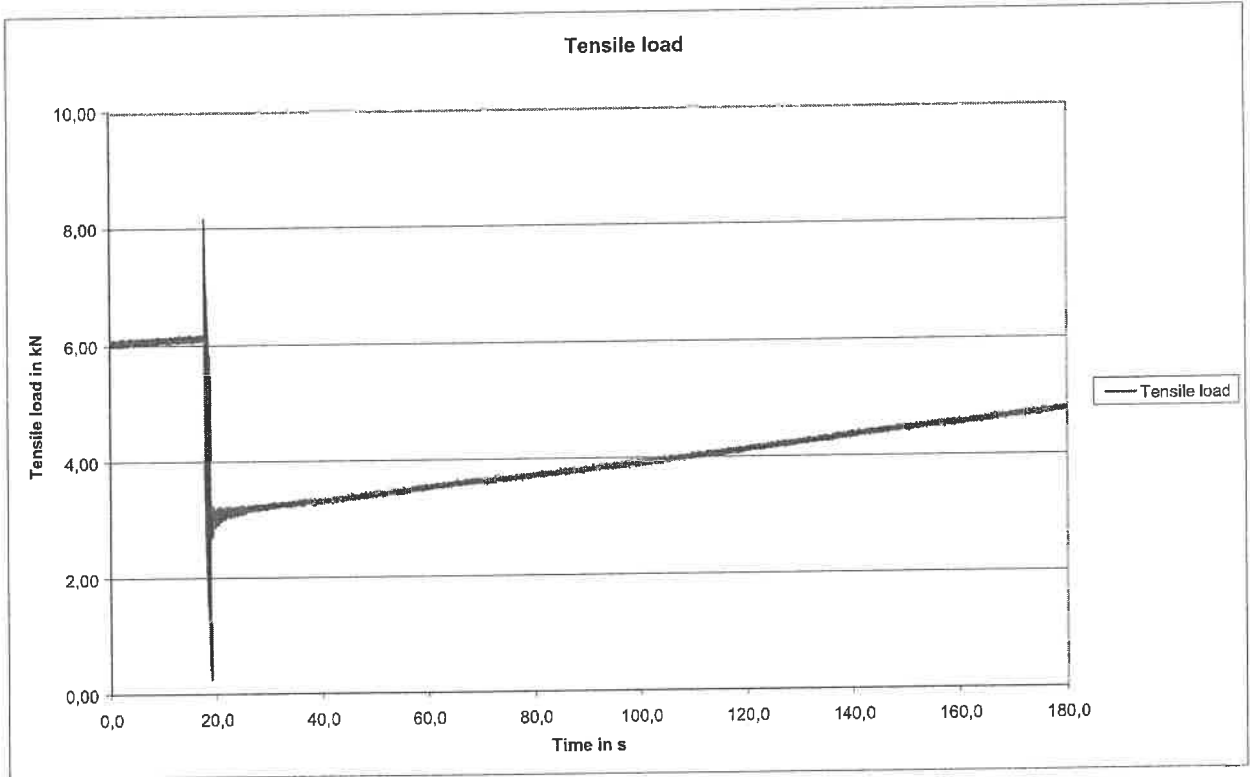

Short circuit current

Test-No.: 11_107

Test 3

04.05.2011

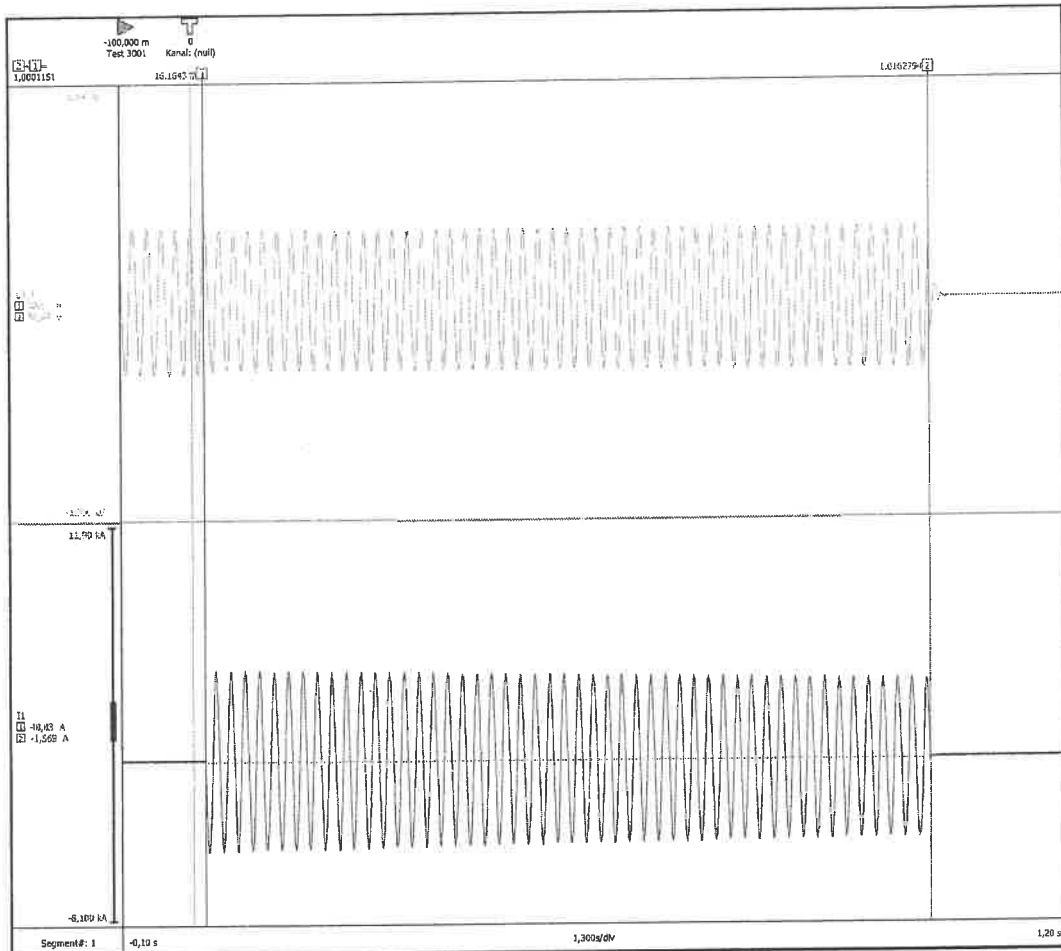

Table

U1 2 eff	237.9	V
U3 1 eff	230.2	V
I1 eff	2.920 k	A
I3 eff	2.895 k	A
I1 ^{2t}	8.530 M	A ² s
I3 ^{2t}	8.384 M	A ² s
I1 max	4.541 k	A
I3 max	4.590 k	A
Time	1.000	s
Winkel cursor	18.00 k	°
Strom im Mittel	2.908 k	A
Winkel im Mittel	25.24	°
LeerSpg	238.2	V

Settings of the high current plant

	L1	L3
U [V]	412	412
R _{slide} [mΩ]	0,5	0,5
R _{fixed} [mΩ]	35	25
X _L	i	i



A Fujikura Business

18.10.2010 WS
120128209300-354216738 TK 10471/10-03

ASLH-D(S)b 36 SMF (A20SA 37 - 2,9)

Optical Ground Wire (OPGW)

according to EN 60794-4 standards

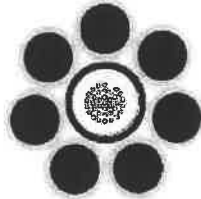

- Stranding direction of outer layer right hand (Z-stranding)
- Wires acc. to EN 61232
- Maximum fibre capacity per steel tube: 36
- Fibres coloured acc. to colour code system D36 F SEC.
- Fibres acc. to G.652
- Impregnated wooden drum with protection

Configuration

Center	1 Stainless Steel Tube with 36 SMF <i>Stainless steel tube material DIN EN 10088-02, Mat. No. 1.4404</i>	2,90 / 3,40 mm
Layer 1	7 A20SA - Wires	2,60 mm

Mechanical Data

Cable Diameter	8,6 mm
Cable Weight	275 kg/km
Supporting Cross Section	37,2 mm ²
Rated Tensile Strength (RTS)	47,3 kN
Ratio RTS / Cable Weight	17,5 km
Modulus of Elasticity	182,0 kN/mm ²
Thermal Elongation Coefficient	13,0 10 ⁻⁶ /K
Permissible Maximum Working Stress (42% RTS)	534,7 N/mm ² (19,9kN)
Recommended Everyday Stress (16% RTS)	203,7 N/mm ² (7,6kN)
Ultimate Exceptional Stress (72% RTS)	916,6 N/mm ² (34,1kN)

Electrical Data

DC Resistance (20°C)	2,325 Ω/km
Conductivity	20,0% IACS
Short Time Current (1,0s, 50-200°C)	2,9 kA
Short Time Current (0,3s, 50-200°C)	5,3 kA
Short Time Current Capacity I ² t (50-200°C)	8,3 kA ² s

Application

Maximum Permissible Installation Force	14,2 kN
Minimum Bending Radius	static 108 mm dynamic 129 mm
Normal Delivery Length	4000 m
Temperature Range	Installation -10 to +50°C Transportation and Operation -40 to +80°C

All Sizes and Values are Nominal Values
www.aftele.com

opgw_pro2.xls Rev. 12.02
AFL Telecommunications GmbH

Examination of the test object

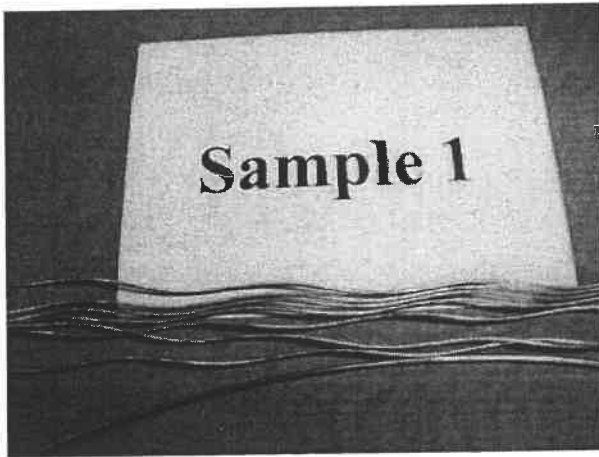

Figure 1: Sample 1

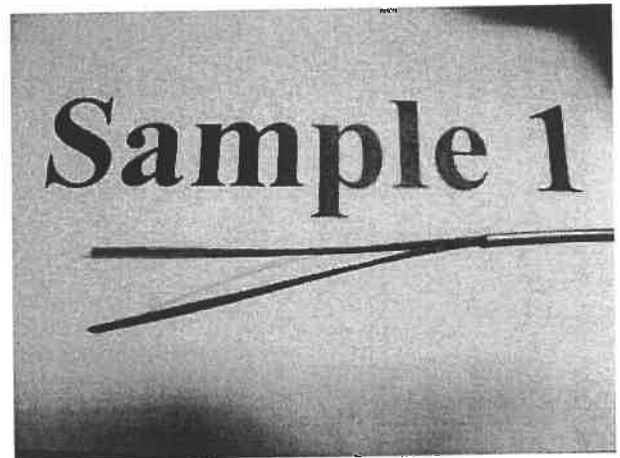

Figure 2: Sample 1

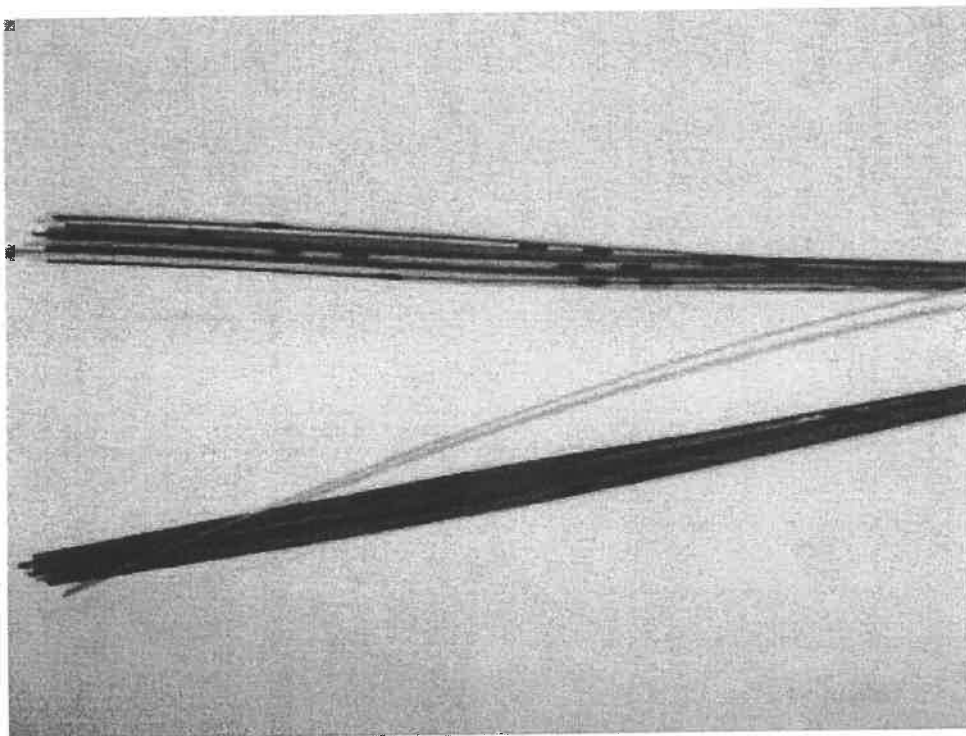

Figure 3: Sample 1

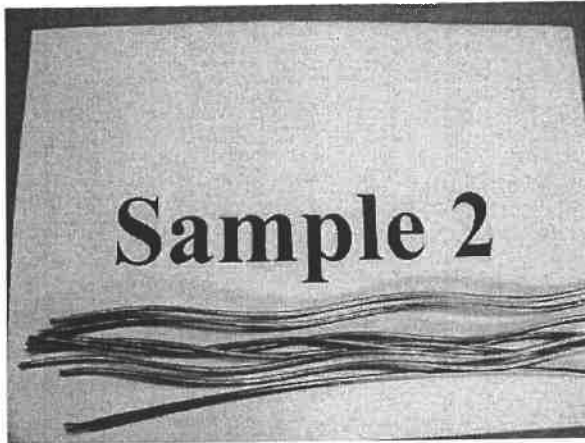

Figure 4: Sample 2

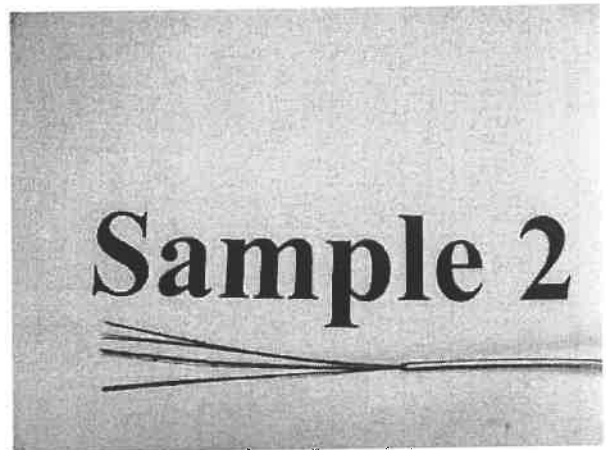

Figure 5: Sample 2

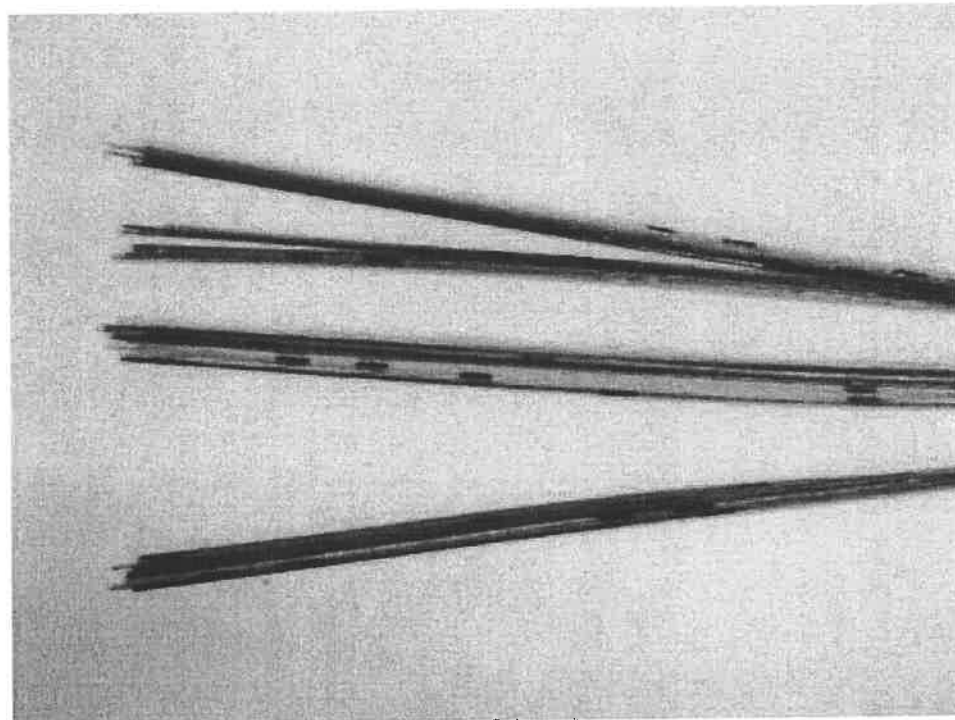

Figure 6: Sample 2

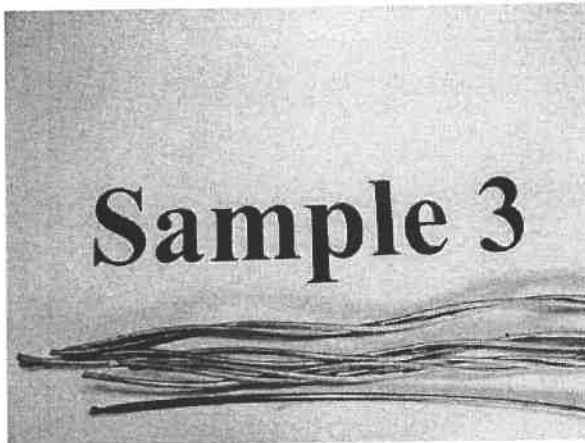

Figure 7: Sample 3

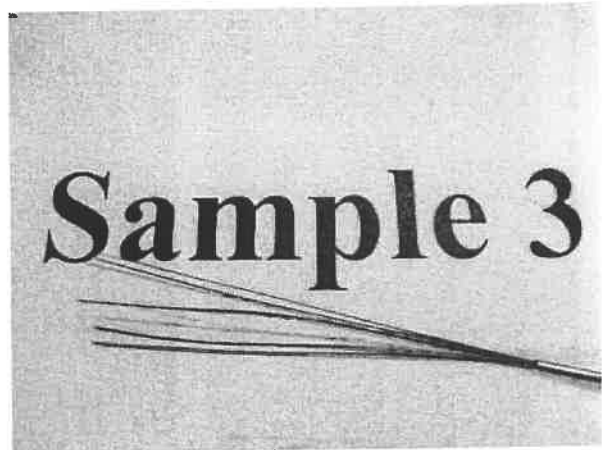

Figure 8: Sample 3

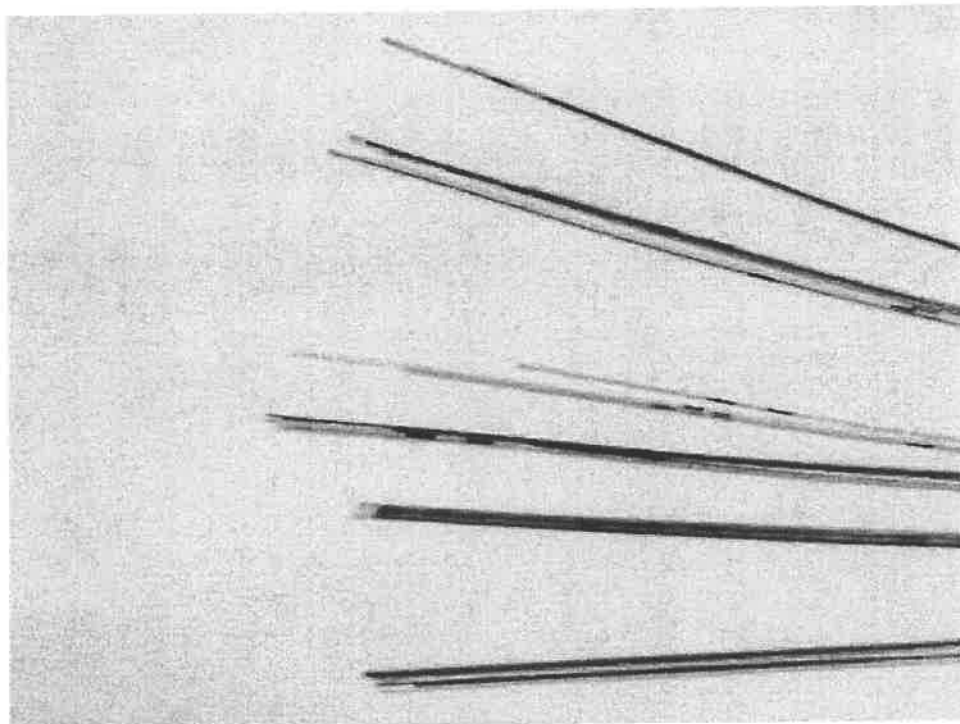

Figure 9: Sample 3



AFL Telecommunications GmbH

Type Test Report

No. TB 2118/11
Date: 05.05.2011
Page: 12

Sheave Test

Annex 5

Cable type: ASLH-D(S)B 36 SMF (A20SA 37 - 2,9)
Cable product spec.: TK 10471/10-03
Cable-ID: 10283527/6735
Test procedure: IEC 60794-1-2-E18

Measurement devices: Stabilised light source
Optical Power Meter
OTDR
Sheave Test bench

Test conditions: sample length: 70m
optical length: min. 100m
wavelength: 1550nm
fibres in a loop: min. 10
test load: 15% RTS
number of cycles: 3
diameter of sheave: 800mm
pulling angle: 2x15°

Requirements: increase of att. 1550nm \leq 1,0 dB/km
no damage of cable components
deformation \leq 0,5mm

Results: no increase of attenuation (0,00 dB/km)/no damage of cable cable components/ no deformation (0,0mm)

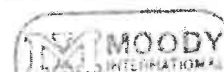

Reviewed
 Witnessed

Date 05.05.11

Заличено по чл. 36а, ал.3 от ЗОП



Test Setup

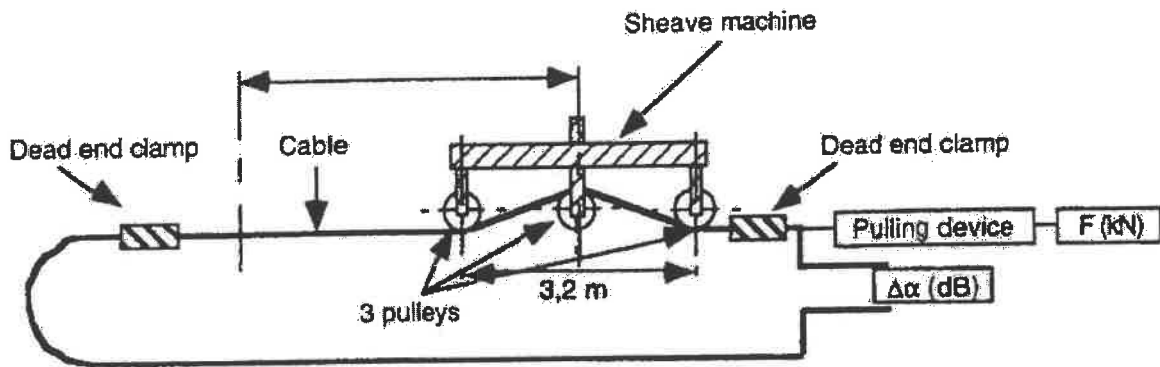

MOODY
INTERNATIONAL
 Reviewed
 Witnessed
Date: 02.05.11

Заличено по чл. 36а, ал.3 от ЗОП



AFL Telecommunications GmbH

Type Test Report

No. TB 2118/11
Date: 05.05.2011
Page: 14

Crush Test

Annex 6

Cable type: ASLH-D(S)B 36 SMF (A20SA 37 – 2,9)
Cable product spec.: TK 10471/10-03
Cable-ID: 10283527/6735
Test procedure: IEC 60794-1-2-E3

Measurement devices: Stabilised light source
Optical Power Meter
OTDR
Crush Test bench

Test conditions: sample length: min. 10m
optical length: min. 100m
wavelength: 1550nm
fibres in a loop: min. 10
load: 1 kN
duration of load: 1 min
number of cycles: 3 (separated by 0,5m)
length of plate: 100mm

Requirements: increase of att. 1550nm \leq 0,1 dB

Results: no increase of attenuation (0,00 dB)

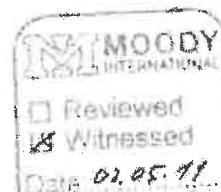

Заличено по чл. 36а, ал.3 от ЗОП



AFL Telecommunications GmbH

Type Test Report

No. TB 2118/11
Date: 05.05.2011
Page: 15

Test Setup

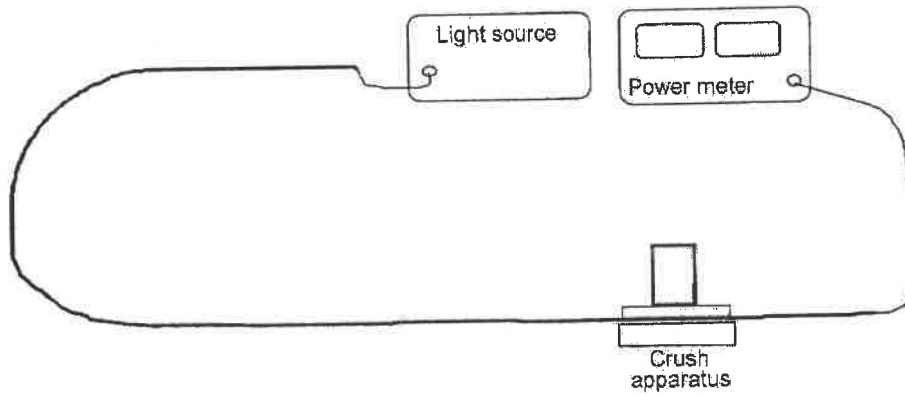

Заличено по чл. 36а, ал.3 от ЗОП





AFL Telecommunications GmbH

Type Test Report

No. TB 2118/11
Date: 05.05.2011
Page: 16

Impact Test

Annex 7

Cable type: ASLH-D(S)B 36 SMF (A20SA 37 – 2,9)
Cable product spec.: TK 10471/10-03
Cable-ID: 10283527/6735
Test procedure: IEC 60794-1-2-E4

Measurement devices: Stabilised light source
Optical Power Meter
OTDR
Impact Test bench

Test conditions: sample length: min. 10m
optical length: min. 100m
wavelength: 1550nm
fibres in a loop: min. 10
Impact Energy: 3 Nm
number of cycles: 20

Requirements: increase of att. 1550nm \leq 0,1 dB

Results: no increase of attenuation (0,00 dB)

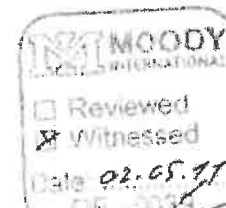

Заличено по чл. 36а, ал.3 от ЗОП



AFL Technological Solutions GmbH

Type Test Report

No. TB 2118/11
Date: 05.05.2011
Page: 17

Stress-Strain Test/Rated Strength Test

Annex 8

Cable type: ASLH-D(S)B 36 SMF (A20SA 37 – 2,9)
Cable product spec.: TK 10471/10-03
Cable-ID: 10283527/6735
Test procedure: IEEE 1138

Measurement devices: Stabilised light source
Optical Power Meter
OTDR
Tensile Test bench

Test conditions: sample length (stress-strain test): min. 50m
sample length (rated strength test): min. 25m
optical length: min. 100m
wavelength: 1550nm

test sequence: no load – pre load – 30%RTS ½h –
pre load – 50%RTS 1h – pre load – 70%RTS 1h – pre load
– 85%RTS 1h – no load
for rated strength test: no load – RTS – no load

Requirements stress-strain test: change of attenuation after test
 $\leq 0,2$ dB/km

Requirements rated strength test: breaking strength $\geq 90\%$ RTS

Results: change of attenuation after test $\leq 0,01$ dB/km
breaking strength $> 100\%$ RTS

MOODY
OF OPTICAL
 Reviewed
 Witnessed
Date: 05.05.11
DE: 0029

Заличено по чл. 36а, ал.3 от ЗОП



AFL Telecommunications GmbH

Type Test Report

No. TB 2118/11
Date: 05.05.2011
Page: 18

Test Setup

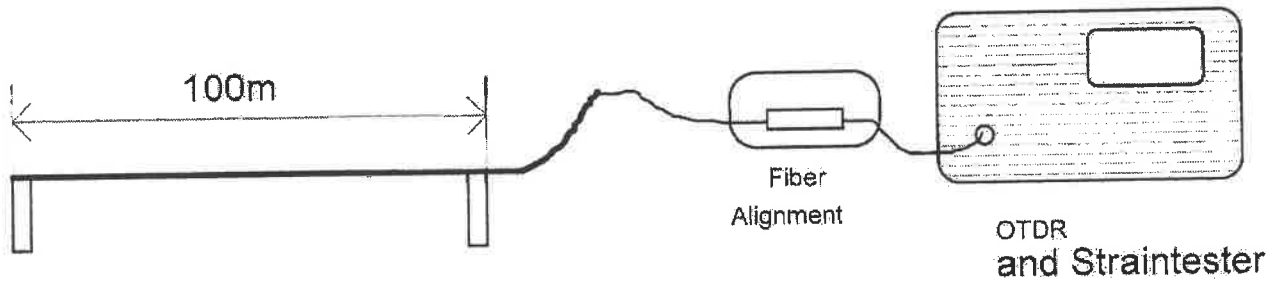

MILMOODY
INTERNATIONAL
 Reviewed
 Witnessed
Date: 02.05.11
DE - 0028

Заличено по чл. 36а, ал.3 от ЗОП

Drehmoment über Kabeldehnung

Zugkraft über Kabeldehnung

60

50

40

30

20

10 / 100

0 Nm

90

80

70

60

50

40

30

20

10

kN

0

1

2

3

4

5

6

7

8

9

10

11

12

%

%

elongation / Dehnung

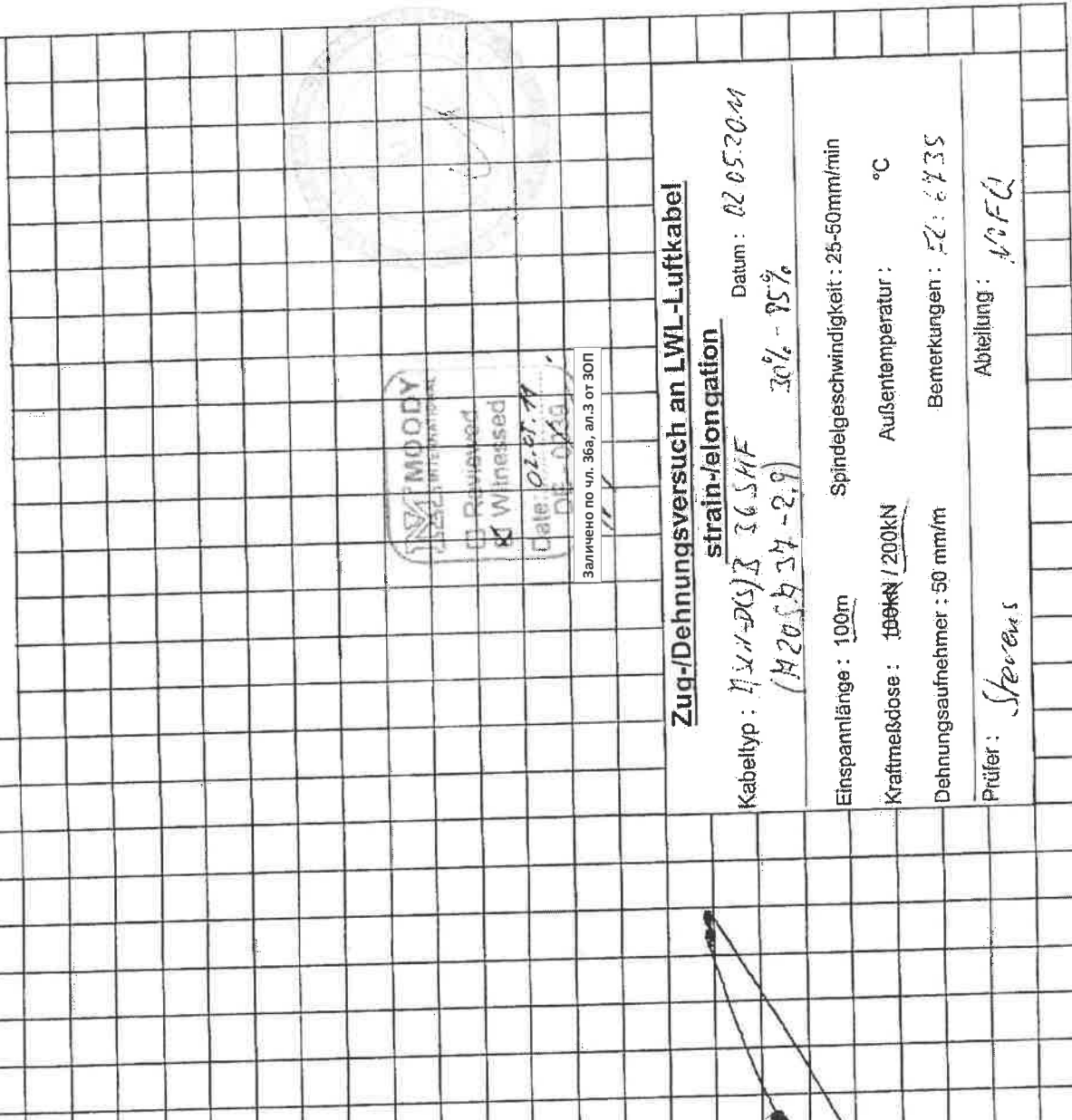

Zug-/Dehnungsversuch an LWL-Luftkabel

strain-/elongation

Kabeltyp : *1x11-D(S)B 36 SHF*
(H205834-2,9) 30% - 95% Datum : 02.05.2011

Einspannlänge : 100m Spindelgeschwindigkeit : 25-50mm/min

Kraftmeßdose : 100kN / 200kN Außentemperatur : °C

Dehnungsaufnehmer : 50 mm/m Bemerkungen : *EL: 6435*

Prüfer : *Stevens* Abteilung : *10FC*

W

AFL 01-004

CD400 Strain Results

Date of measurement : Monday, 02 May 2011 at 09:39:28
 Fiber length : 1,800 km
 Fiber ID : FL6735 30%
 Message : ASLH-D(S)B 36 SMF (A20SA 37 - 2,9)
 Operator : Stevens
 Test file : [1] ASLH1
 Results file name : FL6735 30%.wsd
 System ID : 25220
 Rep rate : 3.0s
 Wavelength : 1550 nm

Sw version : 4.8.3
 Group index : 1.466
 Correction : 0.8

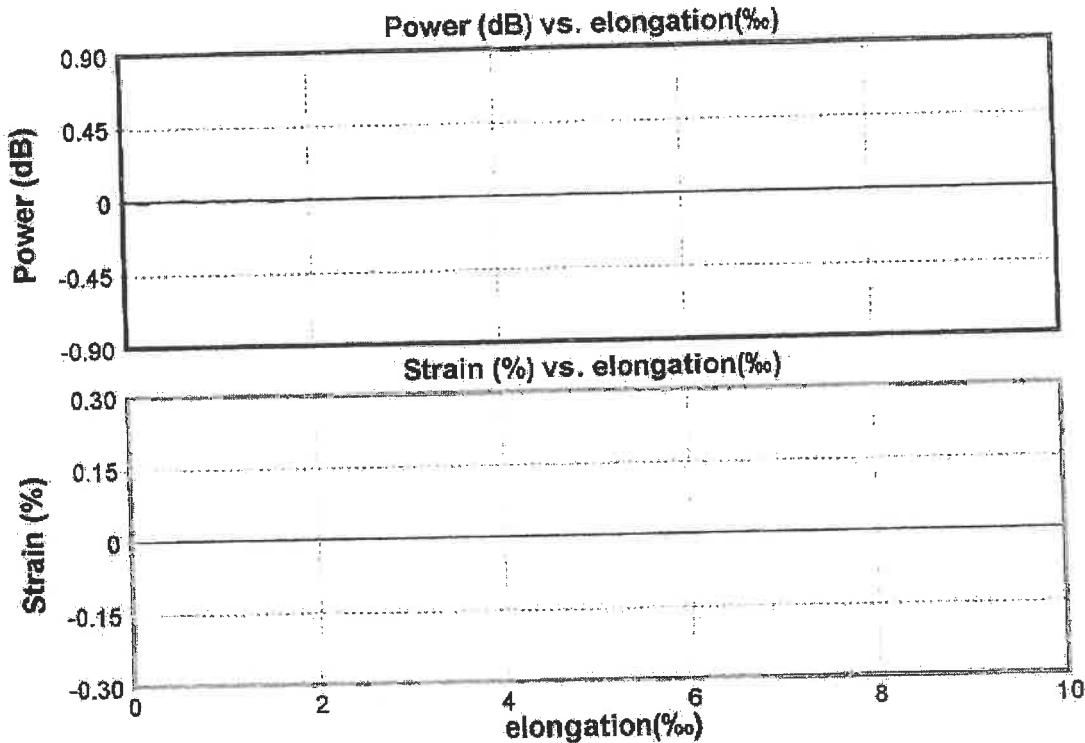

Fiber Fiber input

Power
 Max power = 0.017 dB at 54.6s
 Min power = -0.016 dB at 84.1s

Strain
 Max strain = 0.002 % at 1164.9s
 Min strain = -0.000 % at 2067.4s

EXTERNAL INPUT J18
 Max value = 1.905 elongation(‰) at 1434.7s
 Min value = 0.063 elongation(‰) at 0.0s

Length
 Max length = 34.1 mm at 1164.9s
 Min length = -3.3 mm at 2067.4s

Delay
 Max delay = 133.3 ps at 1164.9s
 Min delay = -12.7 ps at 2067.4s



MOODY INTERNATIONAL

Reviewed
 Witnessed

Date: 02.05.11

Заличено по чл. 36а, ал.3 от ЗОП

VB

AFL 01-004

CD400 Strain Results

Date of measurement : Monday, 02 May 2011 at 10:16:57
 Fiber length : 1.800 km
 Fiber ID : FL6735 50%
 Message : ASLH-D(S)B 36 SMF (A20SA 37 - 2,9)
 Operator : Stevens
 Test file : [1] ASLH1
 Results file name : FL6735 50%.wsd
 System ID : 25220
 Rep rate : 3.0s
 Wavelength : 1550 nm

Sw version : 4.8.3
 Group index : 1.466
 Correction : 0.8

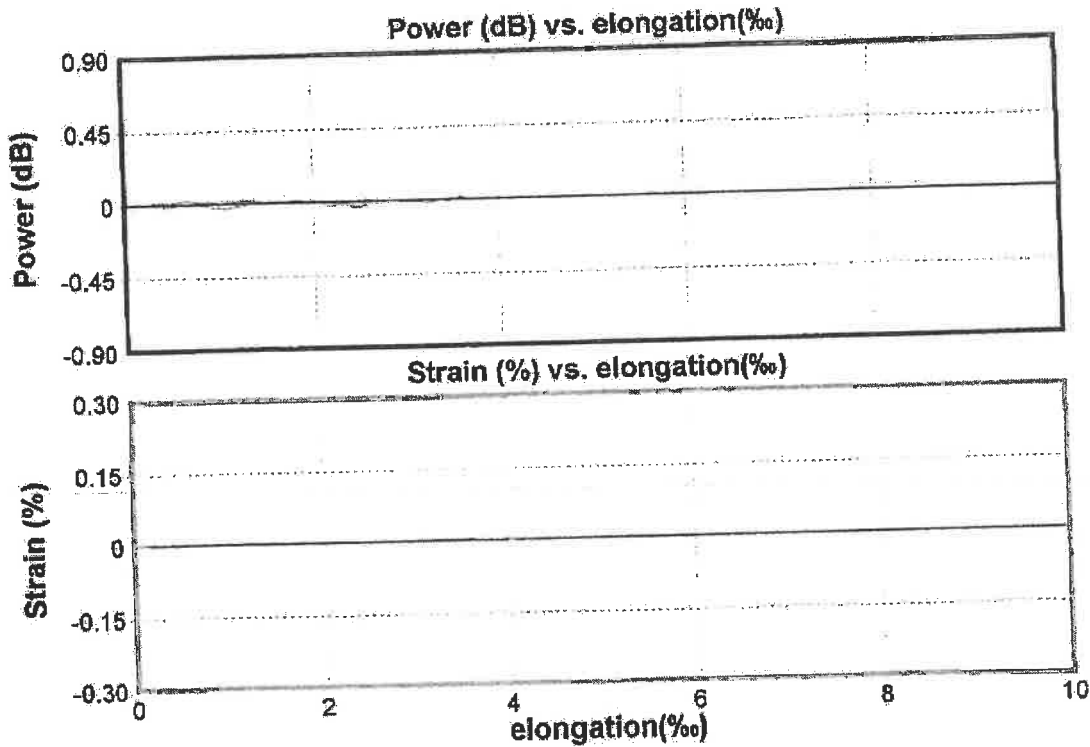

Fiber Fiber input

Power
 Max power = 0.026 dB at 2727.5s
 Min power = -0.026 dB at 4005.5s

Strain
 Max strain = 0.005 % at 3828.8s
 Min strain = 0.000 % at 0.0s

Length
 Max length = 86.7 mm at 3828.8s
 Min length = 0.0 mm at 0.0s

Delay
 Max delay = 339.0 ps at 3828.8s
 Min delay = 0.0 ps at 0.0s

EXTERNAL INPUT J18
 Max value = 3.613 elongation(‰) at 2187.9s
 Min value = 0.199 elongation(‰) at 3.3s



MOODY INTERNATIONAL

Reviewed
 Witnessed
 Date *02.05.11*

Заличено по чл. 36а, ал.3 от ЗОП

Handwritten mark

AFL 01-004

CD400 Strain Results

Date of measurement : Monday,02 May 2011 at 11:27:27
 Fiber length : 1.800 km
 Fiber ID : FL6735 70%
 Message : ASLH-D(S)B 36 SMF (A20SA 37 - 2,9)
 Operator : Stevens
 Test file : [1] ASLH1
 Results file name : FL6735 70%.wsd
 System ID : 25220
 Rep rate : 3.0s
 Wavelength : 1550 nm
 Sw version : 4.8.3
 Group index : 1.466
 Correction : 0.8

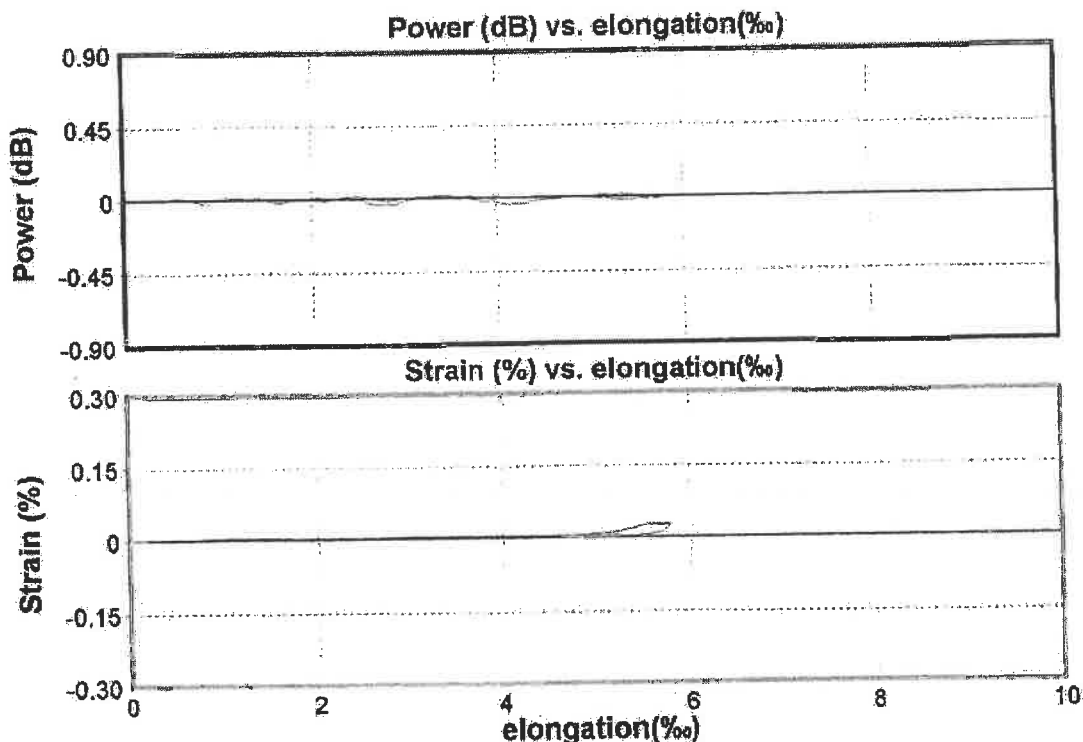

Fiber  Fiber input

Power
 Max power = 0.024 dB at 144.4s
 Min power = -0.036 dB at 4041.1s

Length
 Max length = 532.8 mm at 330.9s
 Min length = 0.0 mm at 0.0s

Strain
 Max strain = 0.030 % at 330.9s
 Min strain = 0.000 % at 0.0s

Delay
 Max delay = 2084.4 ps at 330.9s
 Min delay = 0.0 ps at 0.0s

EXTERNAL INPUT J18
 Max value = 5.785 elongation(‰) at 3495.9s
 Min value = 0.397 elongation(‰) at 3.3s

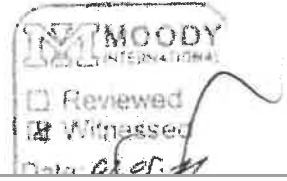

Заличено по чл. 36а, ал.3 от ЗОП

V/B

AFL 01-004

CD400 Strain Results

Date of measurement : Monday, 02 May 2011 at 12:41:11
 Fiber length : 1.800 km
 Fiber ID : FL6735 85%
 Message : ASLH-D(S)B 36 SMF (A20SA 37 - 2,9)
 Operator : Stevens
 Test file : [1] ASLH1
 Results file name : FL6735 85%.wsd
 System ID : 25220
 Rep rate : 3.0s
 Wavelength : 1550 nm

Sw version : 4.8.3
 Group index : 1.466
 Correction : 0.8

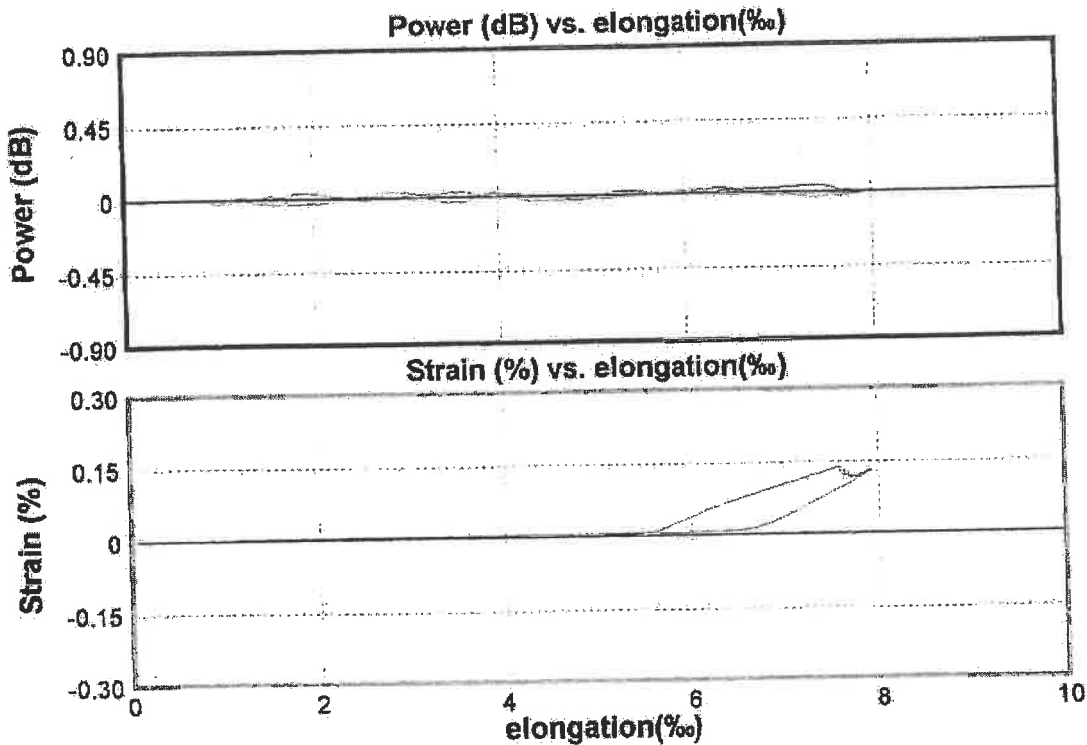

Fiber Fiber input

Power
 Max power = 0.047 dB at 4053.1s
 Min power = -0.028 dB at 228.9s
Strain
 Max strain = 0.139 % at 408.8s
 Min strain = 0.000 % at 0.0s

Length
 Max length = 2499.4 mm at 408.8s
 Min length = 0.0 mm at 0.0s
Delay
 Max delay = 9777.8 ps at 408.8s
 Min delay = 0.0 ps at 0.0s

EXTERNAL INPUT J18
 Max value = 7.930 elongation(‰) at 3837.0s
 Min value = 0.813 elongation(‰) at 6.5s

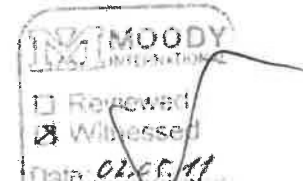

Заличено по чл. 36а, ал.3 от ЗОП

✓

Name AFL

Datum 2011-Mai-02 09:21

0.250km/div 5.000dB/div
[Manuelle Messung]

2 kN Verlust

6735

AFL
CH: Nicht λ: 1550nmSM AVG: 10/10s
DR: 10km IOR: 1.470000 Res: 0.50m
PW: 100ns Att. Auto.

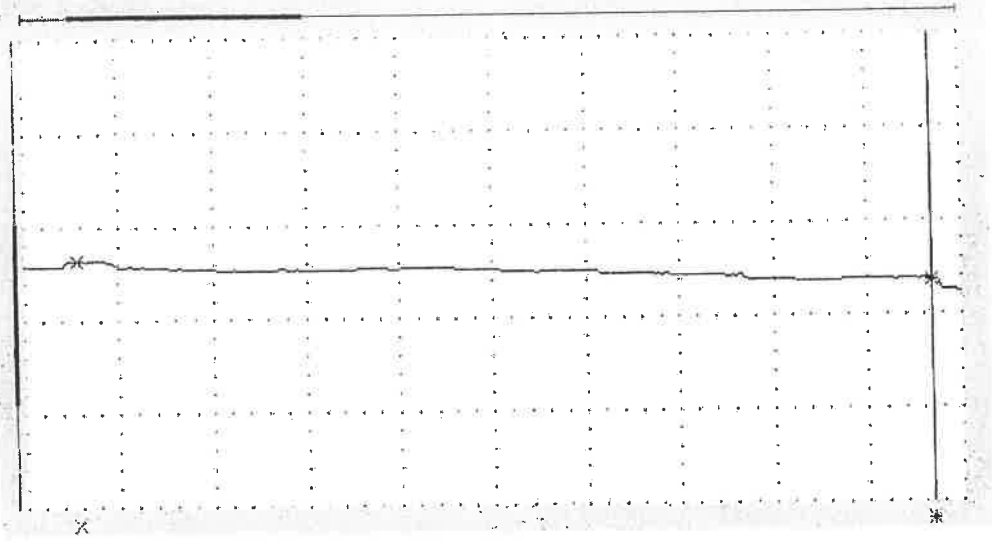

Distanz	:	2.327km	x:	0.658km
Daempfung	:	1.326dB	*:	2.985km
Faserdaempfg	:	0.570dB/km		
Tot. Rueckflusd.	:	40.320dB		
[2PA]				



Заличено по чл. 36а, ал.3 от ЗОП

LD

Name AFL

Datum 2011-Mai-02 09:44

0.250km/div 5.000dB/div
[Manuelle Messung]

30% 14,24N

6735

AFL

CH: Nicht	λ: 1550nmSM	AVG: 10/10s
DR: 10km	IOR: 1.470000	Res: 0.50m
PW: 100ns	Att. Auto.	

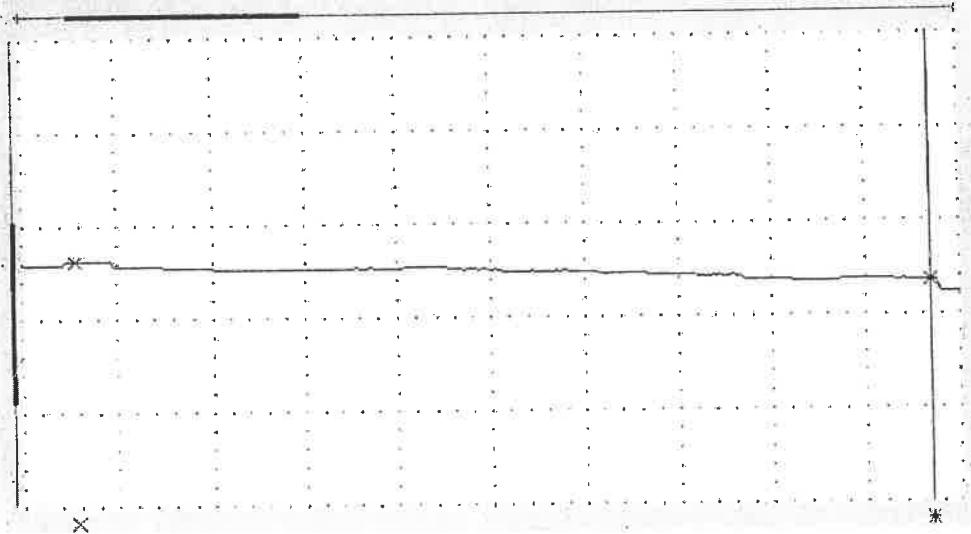

Distanz	:	2.327km	x:	0.658km
Daempfung	:	1.328dB	*	2.985km
Faserdaempfg	:	0.571dB/km		
Tot. Rueckflusd.	:	40.320dB		
[2PA]				

Handwritten signature on the left side of the page.

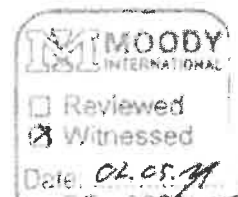

Заличено по чл. 36а, ал.3 от ЗОП

Handwritten mark

Name AFL

Datum 2011-Mai-02 10:00

0.250km/div 5.000dB/div
[Manuelle Messung]

30% 15min

0735

AFL

CH: Nicht λ : 1550nmSM AVG: 10/10s
DR: 10km IOR: 1.470000 Res: 0.50m
PW: 100ns Att. Auto.

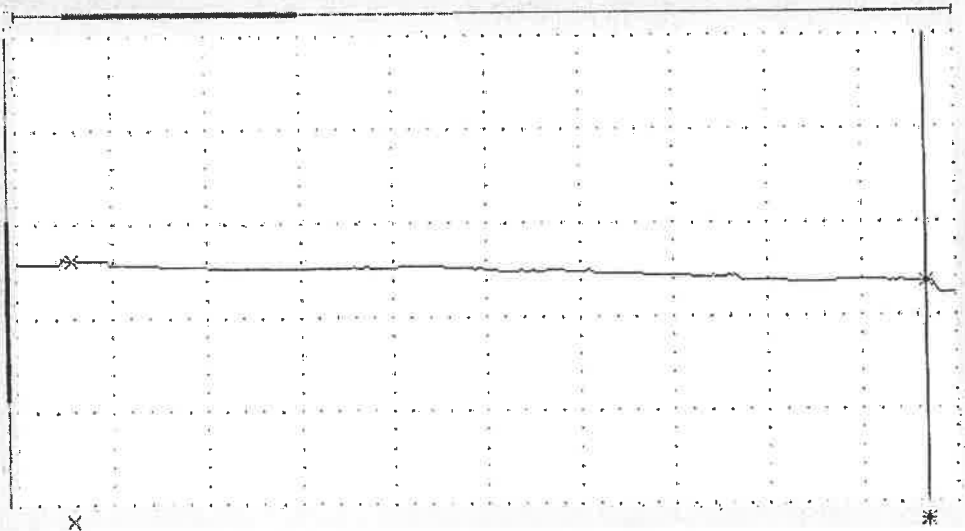

Distanz	:	2.327km	x:	0.658km
Daempfung	:	1.299dB	*:	2.985km
Faserdaempfg	:	0.558dB/km		
Tot. Rueckflusssd.	:	40.323dB		
		[2PA]		

Handwritten signature

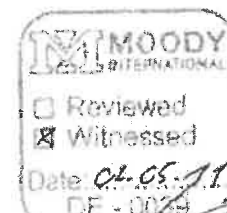

Заличено по чл. 36а, ал.3 от ЗОП

[Handwritten mark]

Name AFL

Datum 2011-Mai-02 10:14

0.250km/div 5.000dB/div

[Manuelle Messung] *30% 30min*

6735

AFL

CH: Nicht	λ : 1550nmSM	AVG: 10/10s
DR: 10km	IOR: 1.470000	Res: 0.50m
PW: 100ns	Att. Auto.	

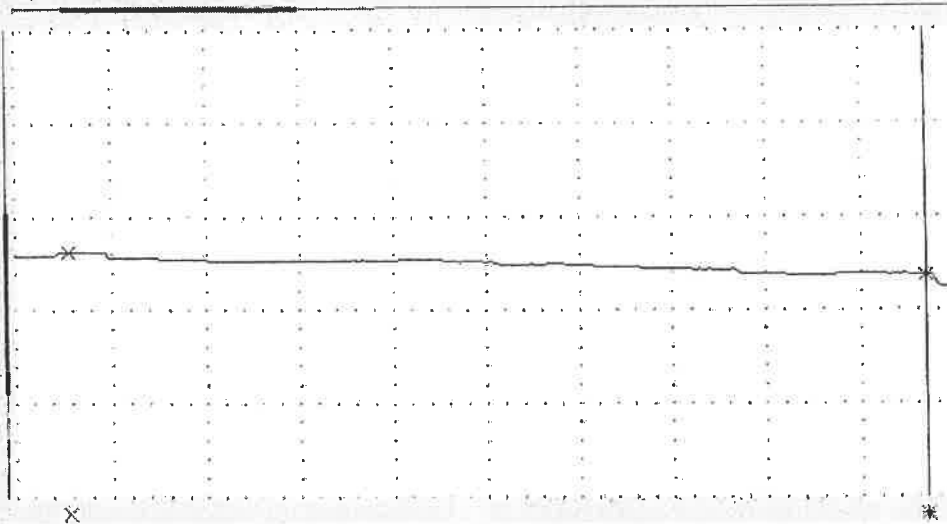

Distanz	:	2.327km	x:	0.658km
Daempfung	:	1.320dB	*:	2.985km
Faserdaempfg	:	0.567dB/km		
Tot. Rueckflusd.	:	40.322dB		
		[2PA]		

[Handwritten signature]



Заличено по чл. 36а, ал.3 от ЗОП

[Handwritten mark]

3

Name AFL

Datum 2011-Mai-02 10:16

0,250km/div 5,000dB/div
[Manuelle Messung]

30% entkoppelt

1735

AFL

CH:	Nicht	λ :	1550nmSM	AVG:	10/10s
DR:	10km	IOR:	1.470000	Res:	0.50m
PW:	100ns	Att:	Auto.		

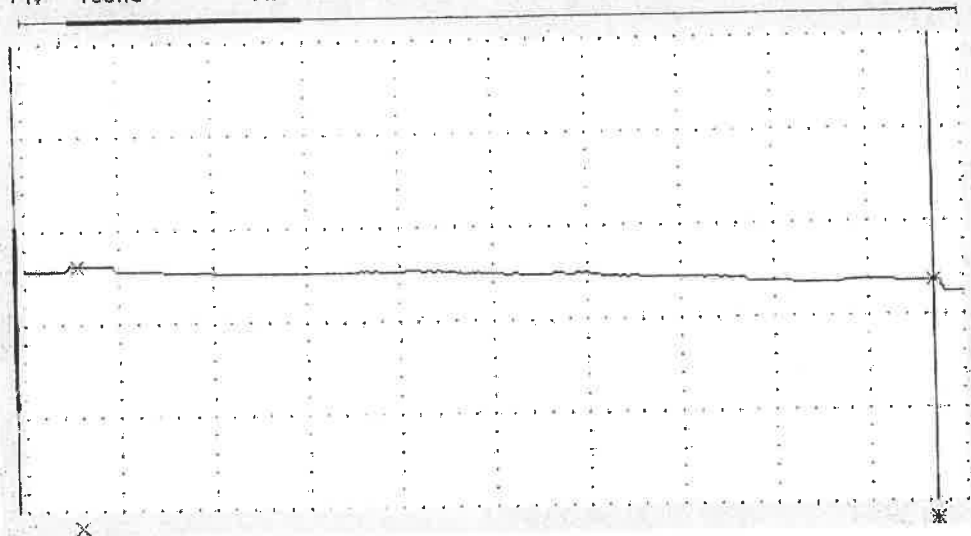

Distanz	:	2.327km	x:	0.658km
Daempfung	:	1.302dB	*:	2.985km
Faserdaempfg	:	0.560dB/km		
Tot. Rueckflusd.	:	40.333dB		
		[2PA]		

[Handwritten signature]



M MOODY
INTERNATIONAL

Reviewed
 Witnessed

Date *02.05.11*

Заличено по чл. 36а, ал.3 от ЗОП

[Handwritten checkmark]

✓

Name AFL

Datum 2011-Mai-02 10:23

0.250km/div 5.000dB/div
[Manuelle Messung] 50% 23,24N

6735

AFL

CH: Nicht λ: 1550nmSM AVG: 10/10s
DR: 10km IOR: 1.470000 Res: 0.50m
PW: 100ns Att. Auto.

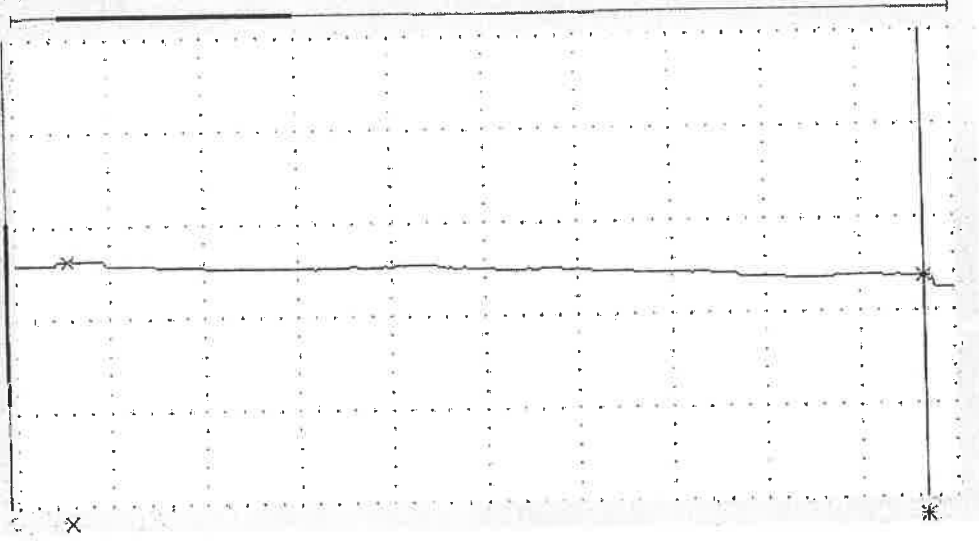

Distanz	:	2.327km	x:	0.658km
Daempfung	:	1.318dB	*:	2.985km
Faserdaempfg	:	0.567dB/km		
Tot. Rueckflusd.	:	40.361dB		
		[2PA]		



MOODY
INTERNATIONAL

Reviewed
 Witnessed

Date: 02.05.11

Заличено по чл. 36а, ал.3 от ЗОП

Handwritten signature on the left side of the page.

Handwritten signature on the right side of the page.

3

Name AFL

Datum 2011-Mai-02 10:37

0.250km/div 5.000dB/div
[Manuelle Messung] 50% 15min

0735

AFL

CH: Nicht	λ : 1550nmSM	AVG: 10/10s
DR: 10km	IOR: 1.470000	Res: 0.50m
PW: 100ns	Att. Auto.	

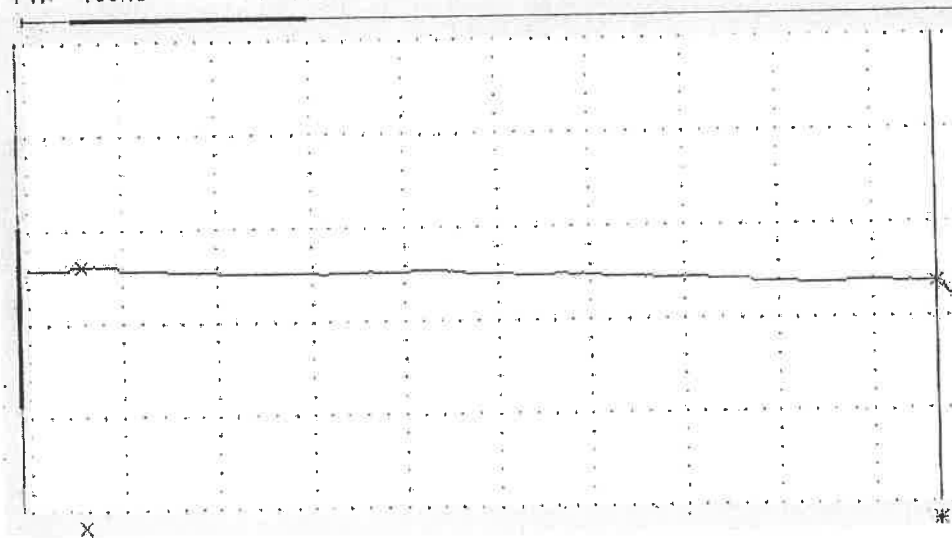

Distanz	:	2.327km	x:	0.658km
Daempfung	:	1.325dB	*	2.985km
Faserdaempfg	:	0.570dB/km		
Tot. Rueckflusd.	:	40.349dB		
[2PA]				

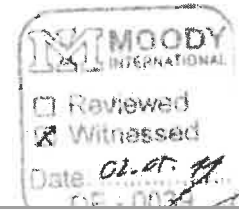

Заличено по чл. 36а, ал.3 от ЗОП

✓

Name AFL

Datum 2011-Mai-02 10:52

0.250km/div 5.000dB/div
[Manuelle Messung] 50% 30min

131

AFL

CH: Nicht	λ: 1550nmSM	AVG: 10/10s
DR: 10km	IOR: 1.470000	Res: 0.50m
PW: 100ns	Att. Auto.	

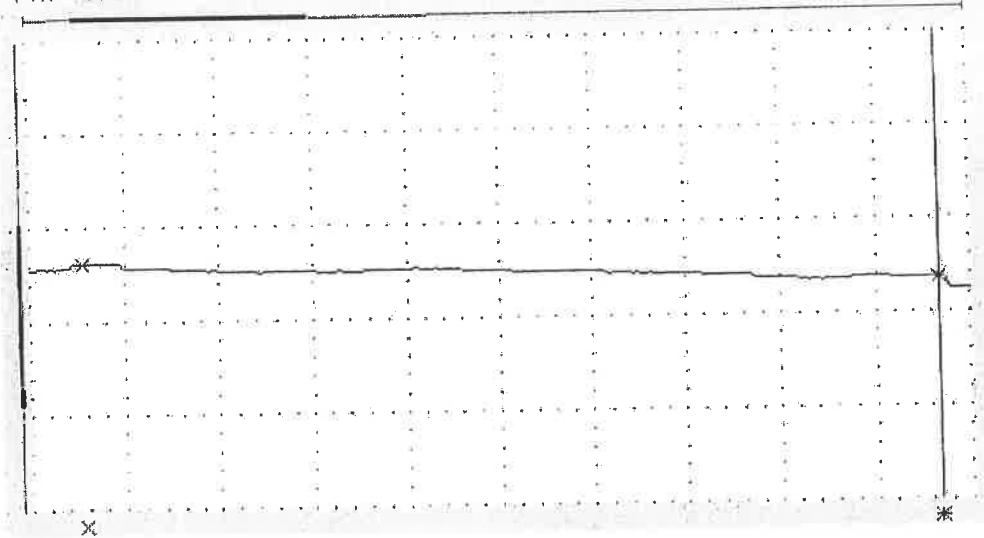

Distanz	:	2.327km	x:	0.658km
Daempfung	:	1.318dB	*:	2.985km
Faserdaempfg	:	0.567dB/km		
Tot. Rueckflusd.	:	40.344dB		
		[2PA]		



MOODY
INTERNATIONAL

Reviewed
 Witnessed
 Date: 02.05.11

Заличено по чл. 36а, ал.3 от ЗОП

VZ

Name AFL

Datum 2011-Mai-02 11:07

0.250km/div 5.000dB/div
[Manuelle Messung] 50% 45min

6735

AFL

CH: Nicht λ: 1550nmSM AVG: 10/10s
DR: 10km IOR: 1.470000 Res: 0.50m
PW: 100ns Att. Auto.

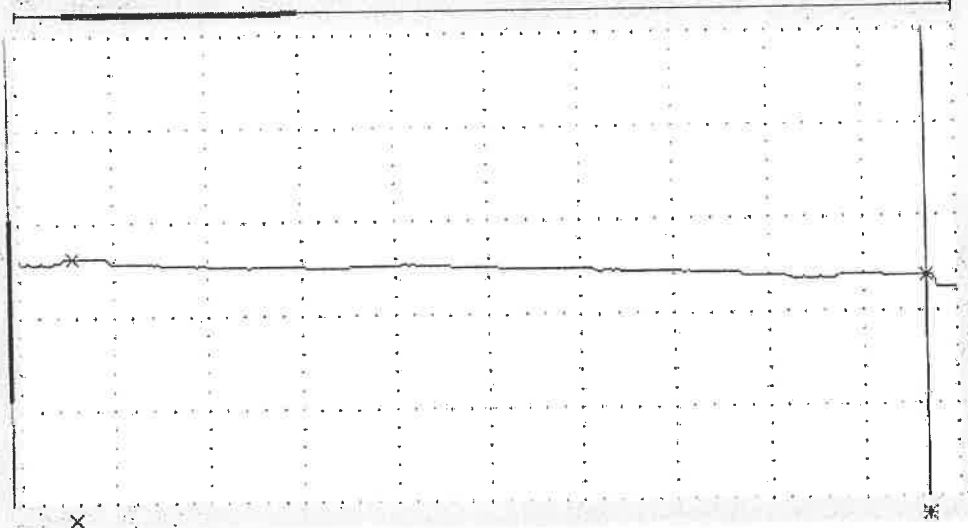

Distanz	:	2.327km	x:	0.658km
Daempfung	:	1.315dB	*	2.985km
Faserdaempfg	:	0.565dB/km		
Tot. Rueckflusssd.	:	40.359dB		
[2PA]				



MOODY INTERNATIONAL
 Reviewed
 Witnessed
 Date 01.05.11
 DE - 0038

Заличено по чл. 36а, ал.3 от ЗОП

VB

Name AFL

Datum 2011-Mai-02 11:22

0.250km/div 5.000dB/div
[Manuelle Messung] *50% 60 Wien*

6735

AFL
CH: Nicht λ: 1550nmSM AVG: 10/10s
DR: 10km IOR: 1.470000 Res: 0.50m
PW: 100ns Att. Auto.

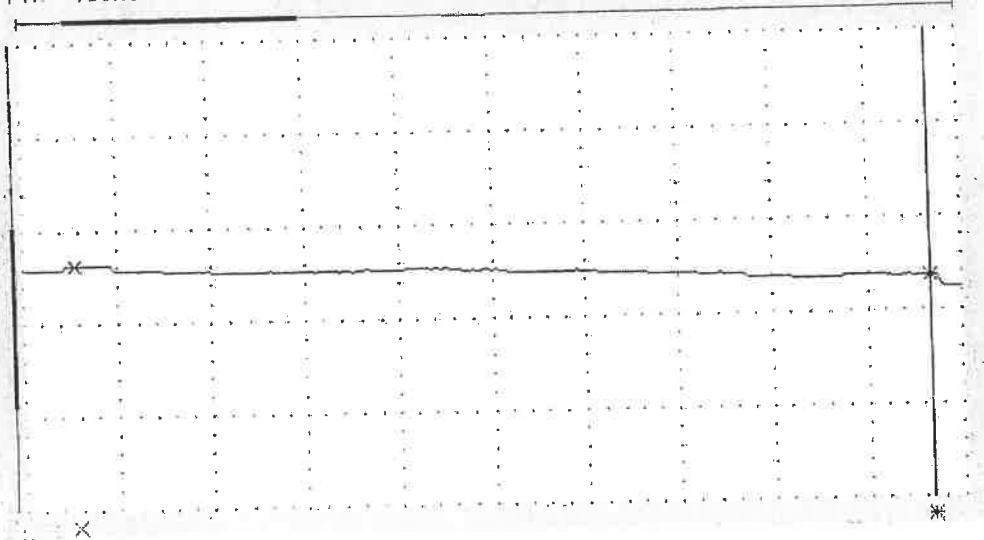

Distanz	:	2.327km	x:	0.658km
Daempfung	:	1.295dB	*:	2.985km
Faserdaempfg	:	0.557dB/km		
Tot. Rueckflusd.	:	40.335dB		
[2PA]				

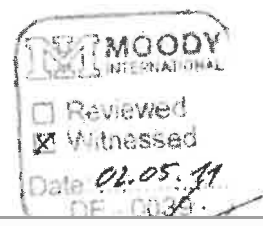

Заличено по чл. 36а, ал.3 от ЗОП

Handwritten mark

Name AFL

Datum 2011-Mai-02 11:27

0.250km/div 5.000dB/div
[Manuelle Messung]

50% entlastet

6735

AFL

CH:	Nicht	λ :	1550nmSM	AVG:	10/10s
DR:	10km	IOR:	1.470000	Res:	0.50m
PW:	100ns	Att:	Auto.		

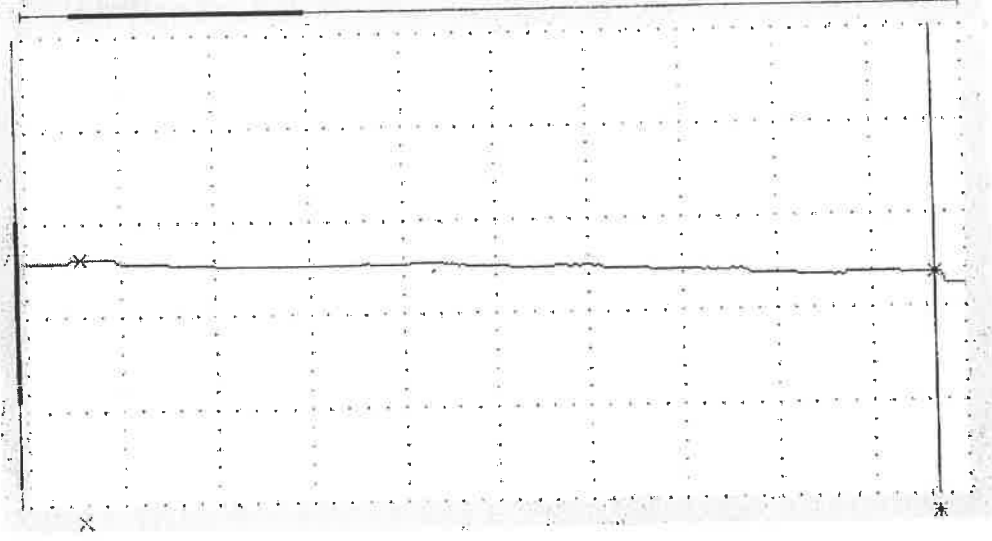

Distanz	:	2.327km	x:	0.658km
Daempfung	:	1.317dB	*:	2.985km
Faserdaempfg	:	0.566dB/km		
Tot. Rueckflussd.	:	40.364dB		
		[2PA]		

Handwritten signature



MOODY
INTERNATIONAL

Reviewed
 Witnessed

Date: *02.05.11*

Заличено по чл. 36а, ал.3 от ЗОП

Handwritten checkmark

LF

Name AFL

Datum 2011-Mai-02 11:35

0.250km/div 5.000dB/div
[Manuelle Messung]

70% 33,4KN

6735

AFL
CH: Nicht λ: 1550nmSM AVG: 10/10s
DR: 10km IOR: 1.470000 Res: 0.50m
PW: 100ns Att. Auto.

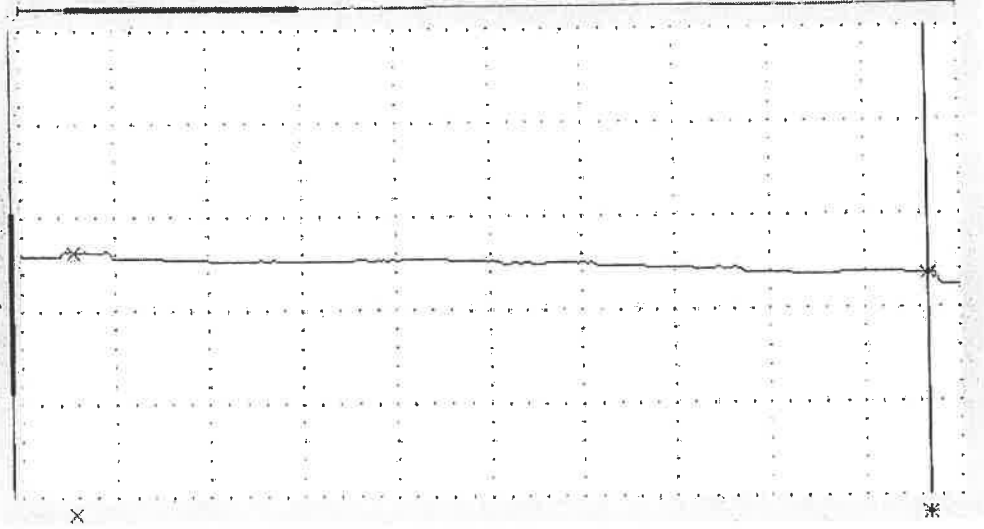

Distanz	:	2.327km	x:	0.658km
Daempfung	:	1.331dB	*:	2.985km
Faserdaempfg	:	0.572dB/km		
Tot. Rueckflusssd.	:	40.336dB		
[2PA]				

Handwritten signature



MOODY INTERNATIONAL
 Reviewed
 Witnessed
 Date 01.05.11

Заличено по чл. 36а, ал.3 от ЗОП

Handwritten checkmark

3

Name AFL

Datum 2011-Mai-02 11:50

0.250km/div 5.000dB/div
[Manuelle Messung]

170⁰ 15 min

1435

AFL

CH: Nicht	λ: 1550nmSM	AVG: 10/10s
DR: 10km	IOR: 1.470000	Res: 0.50m
PW: 100ns	Att. Auto.	

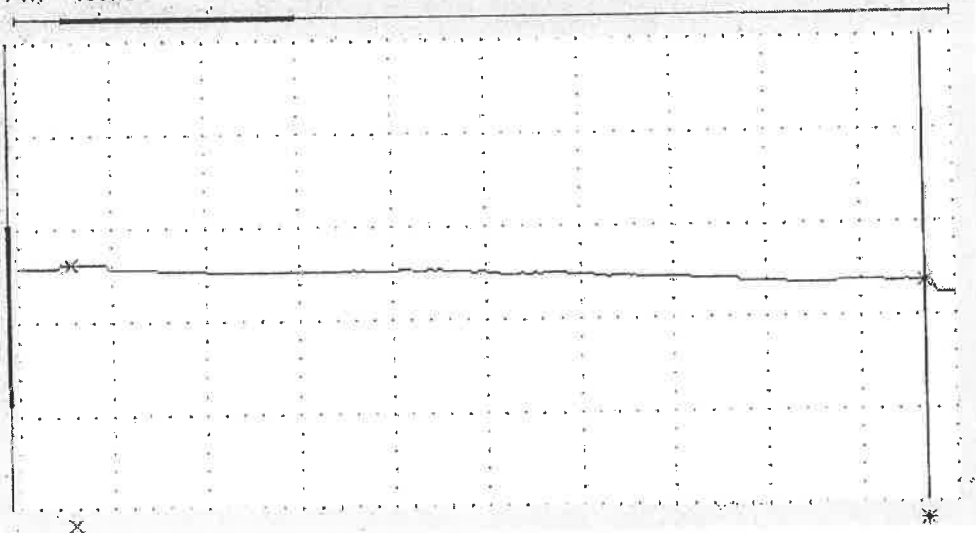

Distanz	:	2.327km	x:	0.658km
Daempfung	:	1.326dB	*:	2.985km
Faserdaempfg	:	0.570dB/km		
Tot. Rueckflusd.	:	40.333dB		
		[2PA]		

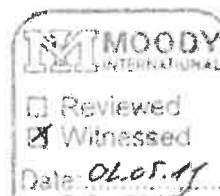

Заличено по чл. 36а, ал.3 от ЗОП

[Handwritten signature]

[Handwritten mark]

3

Name AFL

Datum 2011-Mai-02 12:05

0.250km/div 5.000dB/div
[Manuelle Messung]

70% 30min

6735

AFL

CH: Nicht	λ: 1550nmSM	AVG: 10/10s
DR: 10km	IOR: 1.470000	Res: 0.50m
PW: 100ns	Att. Auto.	

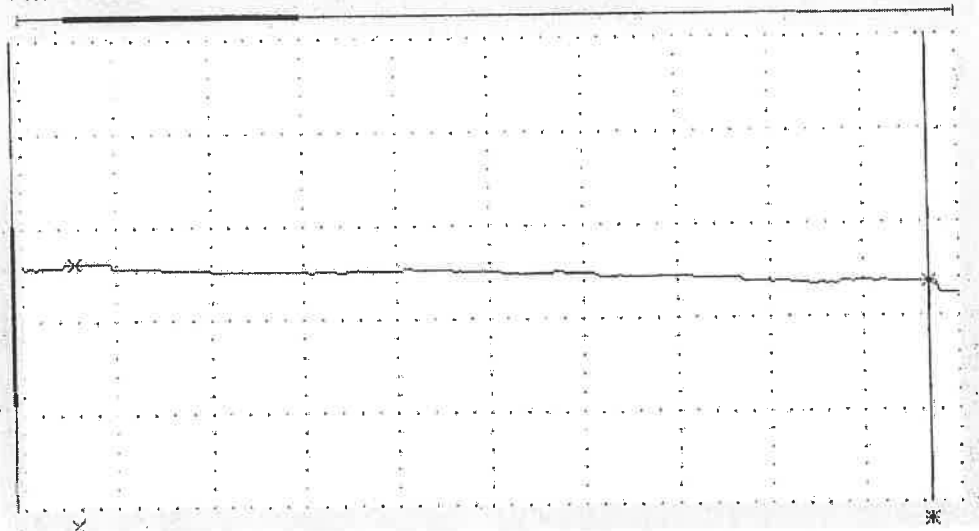

Distanz	:	2.327km	x:	0.658km
Daempfung	:	1.321dB	*:	2.985km
Faserdaempfg	:	0.568dB/km		
Tot. Rueckflusssd.	:	40.351dB		
		[2PA]		



MOODY INTERNATIONAL
 Reviewed
 Witnessed
 Date: 02.05.11

Заличено по чл. 36а, ал.3 от ЗОП

[Handwritten signature]

[Handwritten signature]

✓

Name AFL

Datum 2011-Mai-02 12:20

0.250km/div 5.000dB/div
[Manuelle Messung]

70% 45min

6735

AFL

CH: Nicht λ: 1550nmSM AVG: 10/10s
DR: 10km IOR: 1.470000 Res: 0.50m
PW: 100ns Att. Auto.

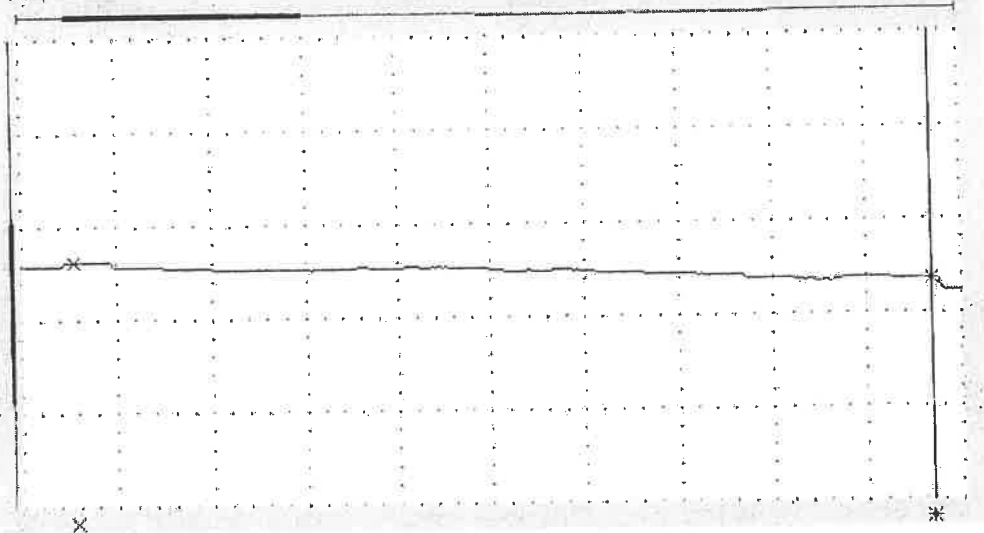

Distanz	:	2.327km	x:	0.658km
Daempfung	:	1.319dB	*:	2.985km
Faserdaempfg	:	0.567dB/km		
Tot. Rueckflusd.	:	40.336dB		
		[2PA]		



MOODY INTERNATIONAL
 Reviewed
 Witnessed
 Date: 02.05.11

Заличено по чл. 36а, ал.3 от ЗОП

Handwritten signature or scribble on the left side of the page.

Handwritten checkmark on the bottom right side of the page.

VB

Name AFL

Datum 2011-Mai-02 12:35

0.250km/div 5.000dB/div

[Manuelle Messung]

20% 60min

6735

AFL

CH: Nicht
DR: 10km
PW: 100ns

λ : 1550nmSM
IOR: 1.470000
Att. Auto.

AVG: 10/10s
Res: 0.50m

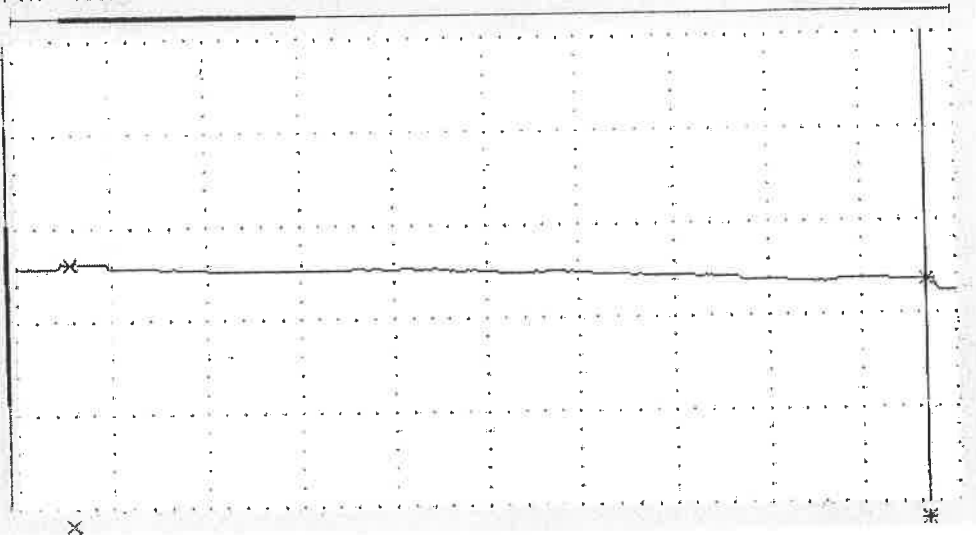

Distanz	:	2.327km	x:	0.658km
Daempfung	:	1.328dB	*:	2.985km
Faserdaempfg	:	0.571dB/km		
Tot. Rueckflusd.	:	40.341dB		
		[2PA]		

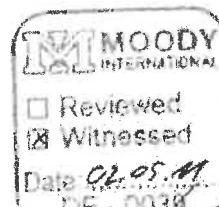

Заличено по чл. 36а, ал.3 от ЗОП

3

Name AFL

Datum 2011-Mai-02 12:40

0.250km/div 5.000dB/div
[Manuelle Messung]

70% entkoppelt

6735

AFL

CH: Nicht	λ: 1550nmSM	AVG: 10/10s
DR: 10km	IOR: 1.470000	Res: 0.50m
PW: 100ns	Att. Auto.	

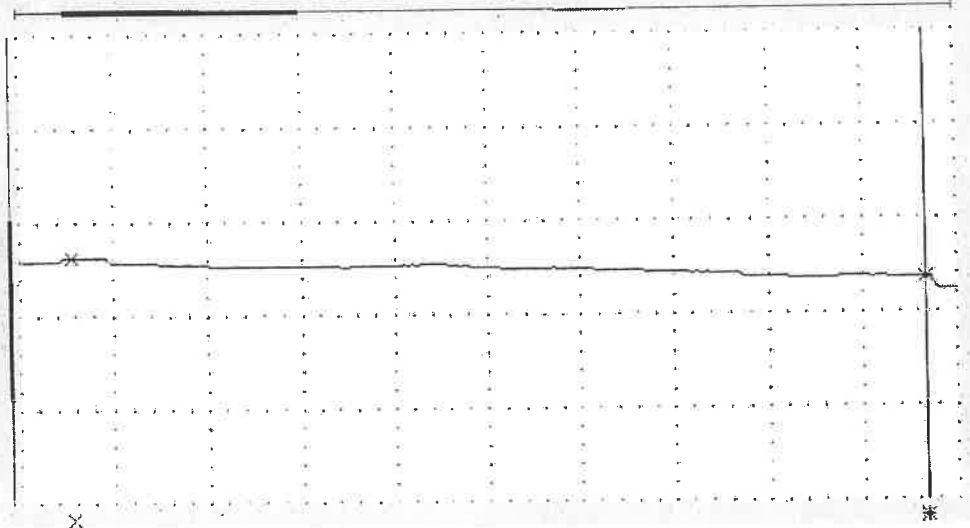

Distanz	:	2.327km	x:	0.658km
Daempfung	:	1.304dB	*:	2.985km
Faserdaempfg	:	0.560dB/km		
Tot. Rueckflusssd.	:	40.331dB		
[2PA]				

[Handwritten signature]

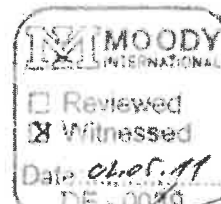

Заличено по чл. 36а, ал.3 от ЗОП

[Handwritten mark]

18

Name AFL

Datum 2011-Mai-02 12:50

0.250km/div 5.000dB/div
[Manuelle Messung]

85% 40,2416

6735

AFL

CH: Nicht	λ: 1550nmSM	AVG: 10/10s
DR: 10km	IOR: 1.470000	Res: 0.50m
PW: 100ns	Att. Auto.	

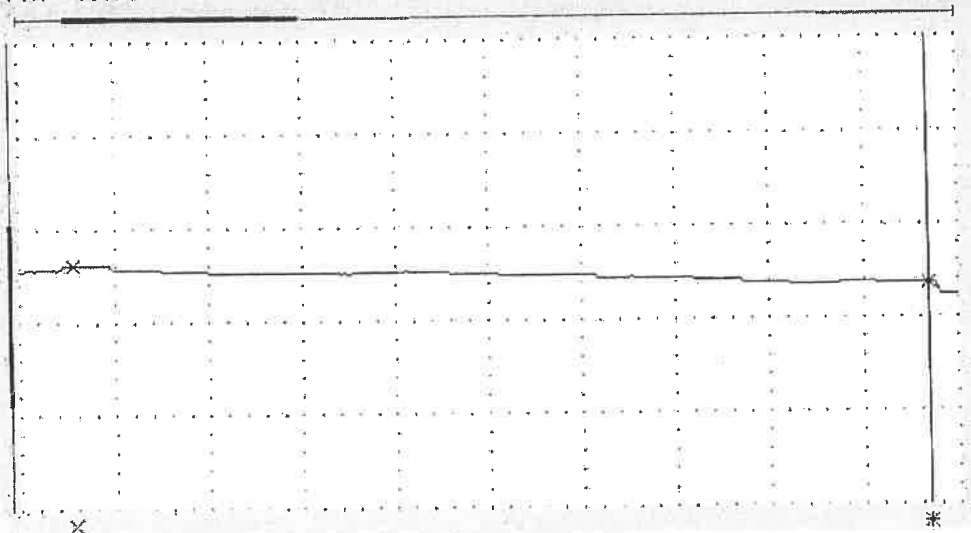

Distanz	:	2.327km	x:	0.658km
Daempfung	:	1.320dB	*:	2.985km
Faserdaempfg	:	0.567dB/km		
Tot. Rueckflusd.	:	40.320dB		
		[2PA]		

[Handwritten signature]



MOODY INTERNATIONAL

Reviewed

Witnessed

Date: 02.05.11

Заличено по чл. 36а, ал.3 от ЗОП

✓

Name AFL

Datum 2011-Mai-02 13:05

0.250km/div 5.000dB/div
[Manuelle Messung]

85% 15 min

6735

AFL

CH:	Nicht	λ:	1550nmSM	AVG:	10/10s
DR:	10km	IOR:	1.470000	Res:	0.50m
PW:	100ns	Att:	Auto.		

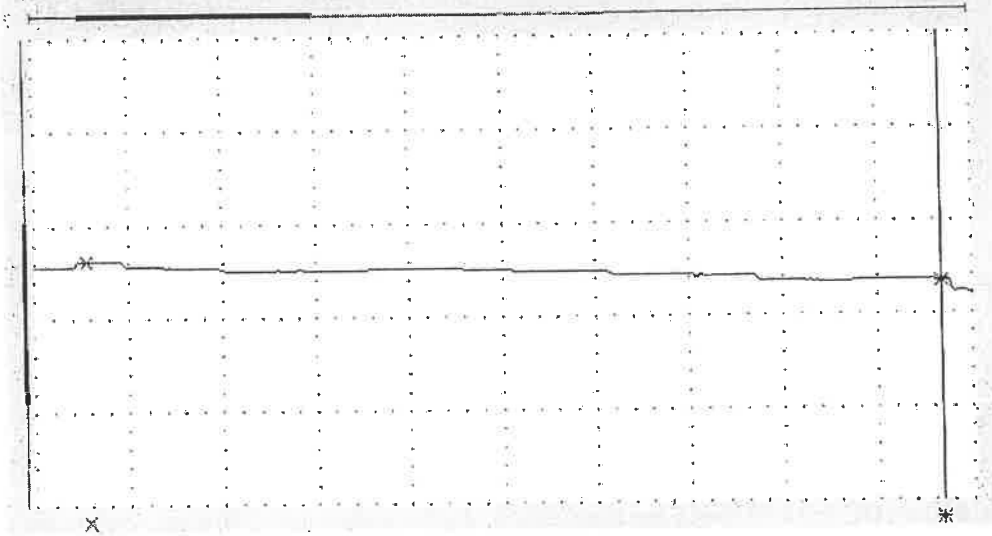

Distanz	:	2.327km	x:	0.658km
Daempfung	:	1.341dB	*:	2.985km
Faserdaempfg	:	0.576dB/km		
Tot. Rueckflusssd.	:	40.334dB		
[2PA]				



MOODY
INTERNATIONAL

Reviewed
 Witnessed

Date 02.05.11

Заличено по чл. 36а, ал.3 от ЗОП

✓

Handwritten mark

Name AFL

Datum 2011-Mai-02 13:20

0.250km/div 5.000dB/div
[Manuelle Messung]

85% 30min

6735

AFL
CH: Nicht λ: 1550nmSM AVG: 10/10s
DR: 10km ICR: 1.470000 Res: 0.50m
PW: 100ns Att. Auto.

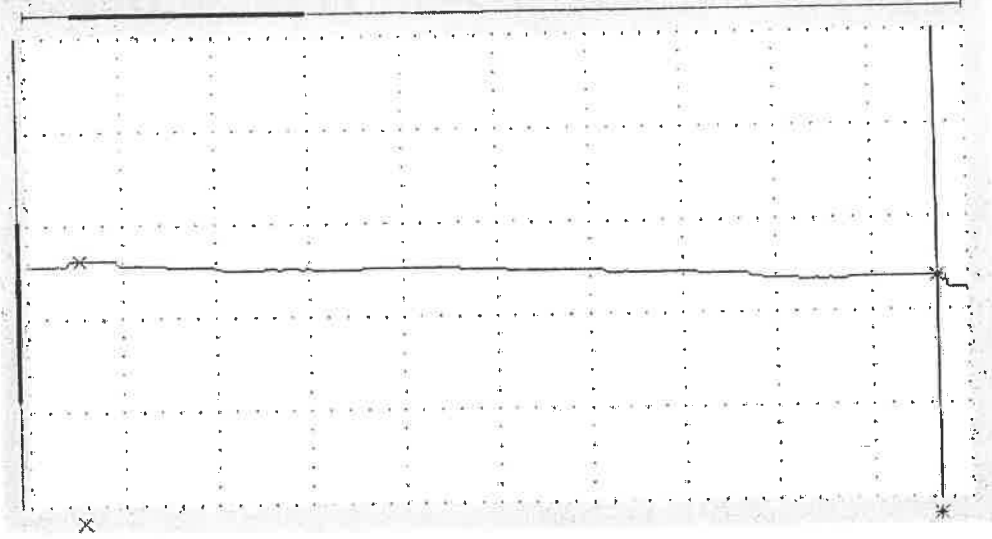

Distanz	:	2.327km	x:	0.658km
Daempfung	:	1.322dB	*:	2.985km
Faserdaempfg	:	0.568dB/km		
Tot. Rueckflusd.	:	40.313dB		
		[2PA]		

Handwritten signature



MOODY
INTERNATIONAL

Reviewed
 Witnessed

Date: *06.05.11*
DF: 0939

Заличено по чл. 36а, ал.3 от ЗОП

Handwritten mark

3

Name AFL

Datum 2011-Mai-02 13:35

0.250km/div 5.000dB/div
[Manuelle Messung]

95% 45 min

67.35

AFL

CH: Nicht	λ: 1550nmSM	AVG: 10/10s
DR: 10km	IOR: 1.470000	Res: 0.50m
PW: 100ns	Att. Auto.	

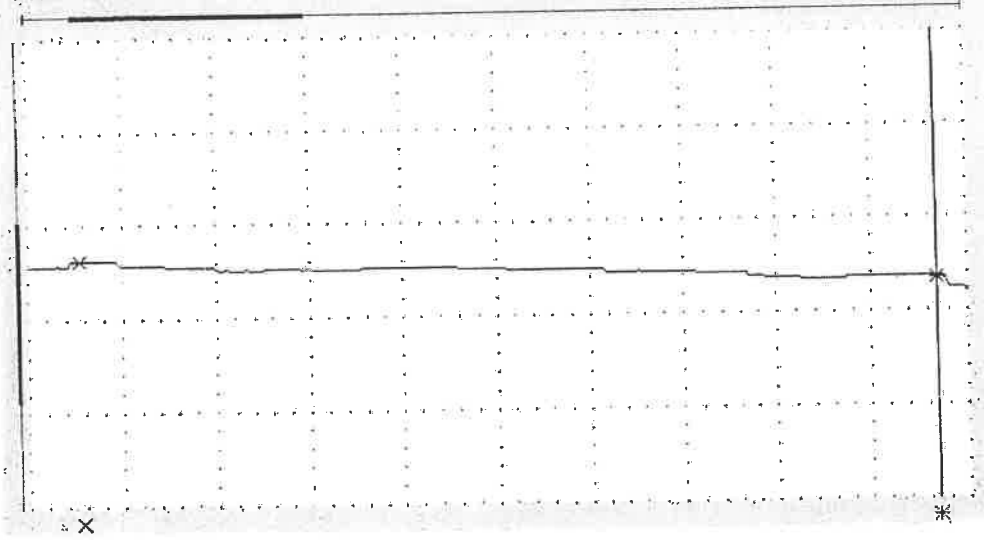

Distanz	:	2.327km	x:	0.658km
Daempfung	:	1.345dB	*:	2.985km
Faserdaempfg	:	0.578dB/km		
Tot. Rueckflusssd.	:	40.344dB		
[2PA]				

[Handwritten signature]



MOODY
INTERNATIONAL

Reviewed
 Witnessed

Date: 02.05.11
 DE 0000

Заличено по чл. 36а, ал.3 от ЗОП

[Handwritten squiggle]

LB

Name AFL

Datum 2011-Mai-02 13:50

0.250km/div 5.000dB/div
[Manuelle Messung]

85% 60 min

6735

AFL

CH: Nicht	λ: 1550nmSM	AVG: 10/10s
DR: 10km	IOR: 1.470000	Res: 0.50m
PW: 100ns	Att. Auto.	

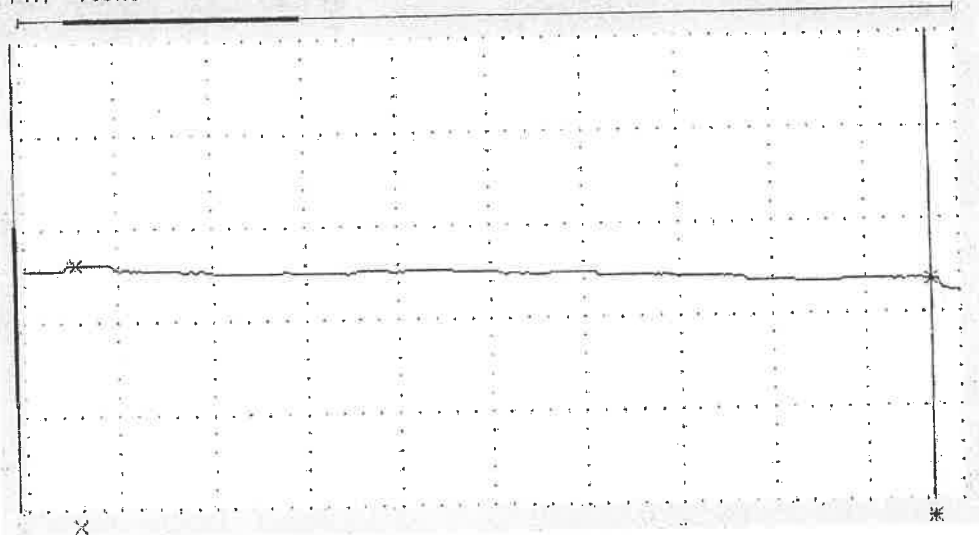

Distanz	:	2.327km	x:	0.658km
Daempfung	:	1.337dB	*	2.985km
Faserdaempfg	:	0.575dB/km		
Tot. Rueckflusd.	:	40.333dB		
[2PA]				

[Handwritten signature]



MOODY
INTERNATIONAL

Reviewed
 Witnessed

Date: 02.05.11

Заличено по чл. 36а, ал.3 от ЗОП

[Handwritten flourish]

7

Name AFL

Datum 2011-Mai-02 13:57

0.250km/div 5.000dB/div
[Manuelle Messung]

75% entlastet

6735

AFL

CH: Nicht	λ : 1550nmSM	AVG: 10/10s
DR: 10km	IOR: 1.470000	Res: 0.50m
PW: 100ns	Att. Auto.	

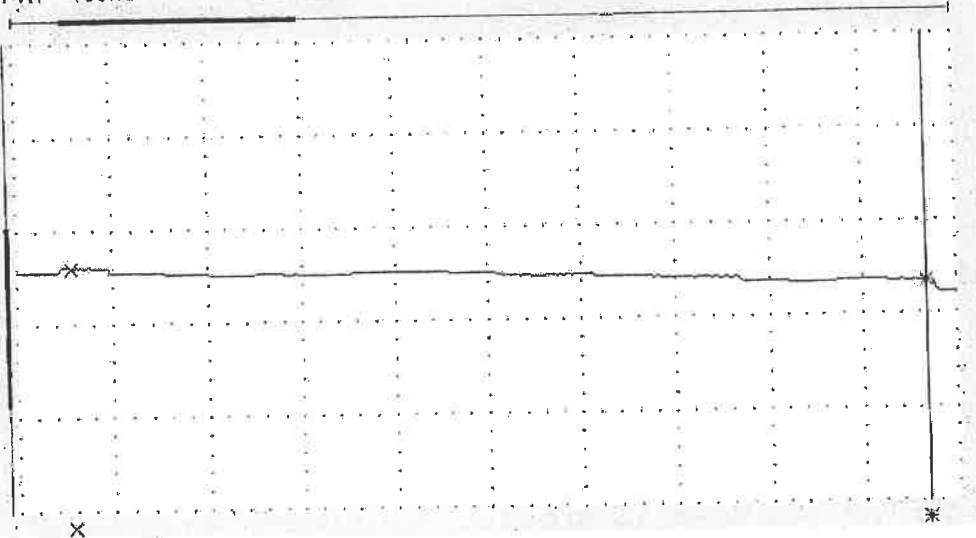

Distanz	:	2.327km	x:	0.658km
Daempfung	:	1.312dB	*	2.985km
Faserdaempfg	:	0.564dB/km		
Tot. Rueckflusd.	:	40.314dB		
[2PA]				

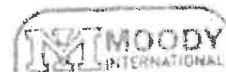

Reviewed
 Witnessed

Date 02.05.11
 DF-0029

Заличено по чл. 36а, ал.3 от ЗОП

AFL 01-004

CD400 Strain Results

Date of measurement : Monday, 02 May 2011 at 15:02:46
 Fiber length : 1.800 km
 Fiber ID : FL6735 100%
 Message : ASLH-D(S)B 36 SMF (A20SA 37 - 2,9)
 Operator : Stevens
 Test file : [2] ASLH2
 Results file name : FL6735 100%.wsd
 System ID : 25220
 Rep rate : 3.0s
 Wavelength : 1550 nm

Sw version : 4.8.3
 Group index : 1.486
 Correction : 0.8

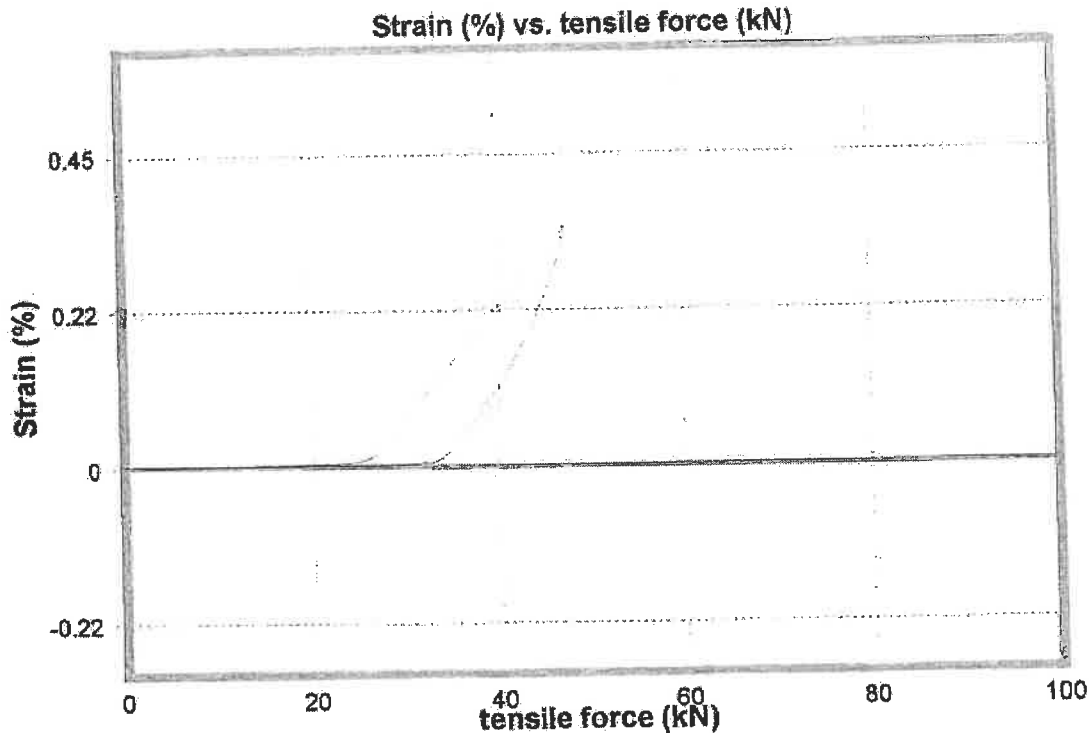

Fiber Fiber input

Power
 Max power = 0.009 dB at 555.9s
 Min power = -0.060 dB at 906.7s
 Strain
 Max strain = 0.344 % at 582.3s
 Min strain = 0.000 % at 0.0s

Length
 Max length = 6189.7 mm at 582.3s
 Min length = 0.0 mm at 0.0s
 Delay
 Max delay = 24214.5 ps at 582.3s
 Min delay = 0.0 ps at 0.0s

EXTERNAL INPUT J18

Max value = 47.420 tensile force (kN) at 576.8s
 Min value = 0.068 tensile force (kN) at 117.8s



MOODY
 INTERNATIONAL
 Reviewed
 Witnessed
 Date: 02.05.11

Заличено по чл. 36а, ал.3 от ЗОП

3



Type Test Report

No. TB 2118/11
Date: 05.05.2011
Page: 19

Temperature Cycling Test

Annex 9

Cable type: ASLH-D(S)B 36 SMF (A20SA 37 – 2,9)
Cable product spec.: TK 10471/10-03
Cable-ID: 10283432/6557
Test procedure: IEC 60794-1-2-F1

Measurement devices: OTDR
Temperature test chamber

Test conditions: sample length: min. 1000m
wavelength: 1550nm
number of measured fibres: min. 10
temperature cycle: -45°C/+85°C
number of cycles: 2

Requirement: increase of att. 1550nm \leq 0,2 dB/km

Results: increase of att. 1550nm \leq 0,014 dB/km



MOODY
INTERNATIONAL
 Reviewed
 Witnessed
Date: 29.04-05.05.11

Заличено по чл. 36а, ал.3 от ЗОП

temperature cycle test

Typ: ASLH-D(S)B 36 SMF (A20SA 37 - 2,9)
 FA: 10283432
 FL: 6657

attenuation at 1310nm

temp.	+20°C/1	+85°C/1	-45°C/1	+85°C/2	-45°C/2	+20°C/2
fibre	(dB/km)	(dB/km)	(dB/km)	(dB/km)	(dB/km)	(dB/km)
1 bl	0,326	0,325	0,318	0,330	0,323	0,326
2 ye	0,332	0,337	0,333	0,339	0,332	0,335
3 gn	0,318	0,318	0,312	0,321	0,315	0,318
4 rd	0,321	0,325	0,315	0,326	0,318	0,322
5 vi	0,328	0,326	0,319	0,332	0,323	0,328
6 wh	0,323	0,324	0,322	0,326	0,318	0,324
7 or	0,315	0,320	0,318	0,325	0,317	0,318
8 br	0,329	0,331	0,327	0,334	0,327	0,329
9 gr	0,326	0,329	0,321	0,330	0,322	0,326
10 nt	0,329	0,328	0,324	0,333	0,326	0,327
11 pi	0,334	0,339	0,332	0,342	0,335	0,337
12 aq	0,331	0,335	0,326	0,337	0,330	0,333
13 bl-50-1	0,323	0,323	0,318	0,328	0,321	0,323
14 ye-50-1	0,338	0,338	0,336	0,343	0,337	0,339
15 gn-50-1	0,325	0,327	0,318	0,330	0,322	0,325
16 rd-50-1	0,317	0,324	0,318	0,324	0,317	0,320
17 vi-50-1	0,329	0,327	0,322	0,333	0,326	0,329
18 wh-50-1	0,323	0,324	0,318	0,329	0,324	0,326
19 or-50-1	0,328	0,328	0,322	0,332	0,326	0,327
20 br-50-1	0,330	0,332	0,324	0,333	0,327	0,329
21 gr-50-1	0,328	0,332	0,322	0,332	0,325	0,329
22 nt-50-1	0,330	0,328	0,321	0,333	0,327	0,330
23 pi-50-1	0,339	0,335	0,328	0,339	0,332	0,336
24 aq-50-1	0,339	0,339	0,334	0,343	0,335	0,337
25 bl-50-2	0,330	0,329	0,324	0,334	0,327	0,330
26 ye-50-2	0,326	0,329	0,318	0,330	0,321	0,326
27 gn-50-2	0,324	0,332	0,322	0,331	0,324	0,327
28 rd-50-2	0,333	0,335	0,329	0,339	0,332	0,335
29 vi-50-2	0,326	0,325	0,321	0,330	0,322	0,326
30 wh-50-2	0,330	0,339	0,331	0,338	0,331	0,335
31 or-50-2	0,339	0,337	0,334	0,343	0,336	0,339
32 br-50-2	0,329	0,329	0,340	0,334	0,328	0,330
33 gr-50-2	0,321	0,323	0,315	0,326	0,318	0,323
34 nt-50-2	0,351	0,349	0,344	0,353	0,348	0,350
35 pi-50-2	0,320	0,325	0,315	0,326	0,319	0,322
36 aq-50-2	0,338	0,339	0,334	0,342	0,334	0,338
min.	0,315	0,318	0,312	0,321	0,315	0,318
max.	0,351	0,349	0,344	0,353	0,348	0,350
mean	0,329	0,330	0,324	0,333	0,326	0,329

MOODY INTERNATIONAL
 Reviewed
 Witnessed
 Date 22.09.2011

Заличено по чл. 36а, ал.3 от ЗОП

temperature cycle test

Typ: ASLH-D(S)B 36 SMF (A20SA 37 - 2,9)
 FA: 10283432
 FL.: 6657

✓

change of attenuation at 1310nm with respect to the 1st 20C measurement

temp.	+85°C/1	-45°C/1	+85°C/2	-45°C/2	+20°C/2
fibre	(dB/km)	(dB/km)	(dB/km)	(dB/km)	(dB/km)
1 bl	-0,001	-0,008	0,004	-0,003	0,000
2 ye	0,005	0,001	0,007	0,000	0,003
3 gn	0,000	-0,006	0,003	-0,003	0,000
4 rd	0,004	-0,006	0,005	-0,003	0,001
5 vi	-0,002	-0,009	0,004	-0,005	0,000
6 wh	0,001	-0,001	0,003	-0,005	0,001
7 or	0,005	0,003	0,010	0,002	0,003
8 br	0,002	-0,002	0,005	-0,002	0,000
9 gr	0,003	-0,005	0,004	-0,004	0,000
10 nt	-0,001	-0,005	0,004	-0,003	-0,002
11 pi	0,005	-0,002	0,008	0,001	0,003
12 aq	0,004	-0,005	0,006	-0,001	0,002
13 bl-50-1	0,000	-0,005	0,005	-0,002	0,000
14 ye-50-1	0,000	-0,002	0,005	-0,001	0,001
15 gn-50-1	0,002	-0,007	0,005	-0,003	0,000
16 rd-50-1	0,007	0,001	0,007	0,000	0,003
17 vi-50-1	-0,002	-0,007	0,004	-0,003	0,000
18 wh-50-1	0,001	-0,005	0,006	0,001	0,003
19 or-50-1	0,000	-0,006	0,004	-0,002	-0,001
20 br-50-1	0,002	-0,006	0,003	-0,003	-0,001
21 gr-50-1	0,004	-0,006	0,004	-0,003	0,001
22 nt-50-1	-0,002	-0,009	0,003	-0,003	0,000
23 pi-50-1	-0,004	-0,011	0,000	-0,007	-0,003
24 aq-50-1	0,000	-0,005	0,004	-0,004	-0,002
25 bl-50-2	-0,001	-0,006	0,004	-0,003	0,000
26 ye-50-2	0,003	-0,008	0,004	-0,005	0,000
27 gn-50-2	0,008	-0,002	0,007	0,000	0,003
28 rd-50-2	0,002	-0,004	0,006	-0,001	0,002
29 vi-50-2	-0,001	-0,005	0,004	-0,004	0,000
30 wh-50-2	0,009	0,001	0,008	0,001	0,005
31 or-50-2	-0,002	-0,005	0,004	-0,003	0,000
32 br-50-2	0,000	0,011	0,005	-0,001	0,001
33 gr-50-2	0,002	-0,006	0,005	-0,003	0,002
34 nt-50-2	-0,002	-0,007	0,002	-0,003	-0,001
35 pi-50-2	0,005	-0,005	0,006	-0,001	0,002
36 aq-50-2	0,001	-0,004	0,004	-0,004	0,000
min.	-0,004	-0,011	0,000	-0,007	-0,003
max.	0,009	0,011	0,010	0,002	0,005
mean	0,002	-0,004	0,005	-0,002	0,001

✓

✓



MOODY INTERNATIONAL
 Reviewed
 Witnessed
 Date 27.04.05.05.11

✓

Заличено по чл. 36а, ал.3 от ЗОП

temperature cycle test

Typ: ASLH-D(S)B 36 SMF (A20SA 37 - 2,9)
 FA: 10283432
 FL: 6657

3

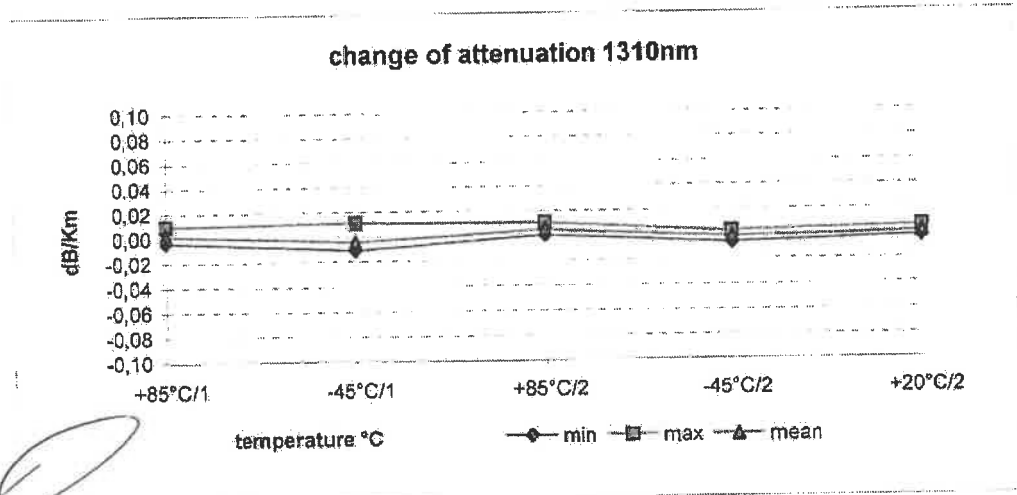
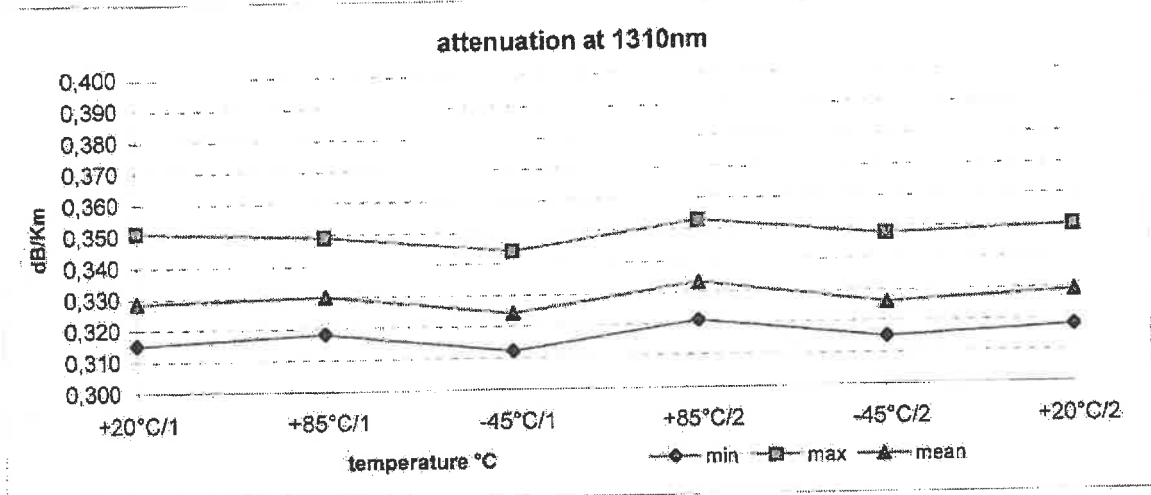

[Handwritten signature]

[Faint circular stamp]

MOODY
 INTERNATIONAL
 Reviewed
 Witnessed
 Date 29.04-2005.M.
 DE - 0079

[Handwritten mark]

Заличено по чл. 36а, ал.3 от ЗОП

temperature cycle test

Typ: ASLH-D(S)B 36 SMF (A20SA 37 - 2,9)
 FA: 10283432
 FL: 6657

V B

attenuation at 1550nm

temp.	+20°C/1	+85°C/1	-45°C/1	+85°C/2	-45°C/2	+20°C/2	
fibre	(dB/km)	(dB/km)	(dB/km)	(dB/km)	(dB/km)	(dB/km)	
1	bl	0,192	0,193	0,184	0,194	0,191	0,192
2	ye	0,197	0,204	0,199	0,205	0,198	0,201
3	gn	0,185	0,189	0,184	0,188	0,184	0,186
4	rd	0,189	0,190	0,188	0,192	0,187	0,189
5	vi	0,189	0,195	0,187	0,193	0,188	0,190
6	wh	0,194	0,196	0,192	0,197	0,189	0,192
7	or	0,188	0,194	0,190	0,195	0,190	0,191
8	br	0,192	0,196	0,191	0,196	0,190	0,191
9	gr	0,194	0,197	0,191	0,198	0,192	0,194
10	nt	0,194	0,192	0,191	0,194	0,190	0,192
11	pi	0,199	0,203	0,198	0,204	0,199	0,199
12	aq	0,196	0,200	0,189	0,202	0,195	0,197
13	bl-50-1	0,192	0,191	0,187	0,196	0,191	0,192
14	ye-50-1	0,199	0,202	0,199	0,202	0,199	0,198
15	gn-50-1	0,194	0,197	0,190	0,195	0,190	0,192
16	rd-50-1	0,187	0,193	0,187	0,193	0,187	0,189
17	vi-50-1	0,192	0,192	0,189	0,195	0,190	0,191
18	wh-50-1	0,192	0,191	0,184	0,194	0,189	0,192
19	or-50-1	0,190	0,195	0,191	0,196	0,191	0,193
20	br-50-1	0,193	0,197	0,192	0,196	0,191	0,192
21	gr-50-1	0,197	0,200	0,195	0,200	0,195	0,197
22	nt-50-1	0,194	0,194	0,188	0,196	0,192	0,193
23	pi-50-1	0,199	0,200	0,199	0,203	0,197	0,198
24	aq-50-1	0,196	0,197	0,194	0,200	0,195	0,197
25	bl-50-2	0,196	0,198	0,189	0,199	0,194	0,196
26	ye-50-2	0,193	0,197	0,190	0,195	0,190	0,193
27	gn-50-2	0,194	0,198	0,194	0,200	0,193	0,195
28	rd-50-2	0,197	0,196	0,195	0,201	0,197	0,198
29	vi-50-2	0,193	0,193	0,188	0,196	0,190	0,192
30	wh-50-2	0,198	0,201	0,197	0,202	0,196	0,198
31	or-50-2	0,201	0,201	0,199	0,204	0,200	0,202
32	br-50-2	0,195	0,193	0,209	0,197	0,194	0,194
33	gr-50-2	0,193	0,194	0,190	0,196	0,191	0,193
34	nt-50-2	0,207	0,208	0,204	0,209	0,210	0,207
35	pi-50-2	0,190	0,197	0,191	0,197	0,192	0,194
36	aq-50-2	0,198	0,201	0,194	0,201	0,196	0,197
	min.	0,185	0,189	0,184	0,188	0,184	0,186
	max.	0,207	0,208	0,209	0,209	0,210	0,207
	mean	0,194	0,197	0,192	0,198	0,193	0,194

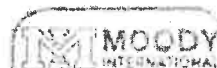

Reviewed
 Witnessed

Date 27.04-05.05.11

Заличено по чл. 36а, ал.3 от ЗОП

temperature cycle test

Typ: ASLH-D(S)B 36 SMF (A20SA 37 - 2,9)
 FA: 10283432
 FL: 6657

Handwritten mark

change of attenuation at 1550nm with respect to the 1st 20C measurement

temp.	+85°C/1	-45°C/1	+85°C/2	-45°C/2	+20°C/2	
fibre	(dB/km)	(dB/km)	(dB/km)	(dB/km)	(dB/km)	
1	bl	0,001	-0,008	0,002	-0,001	0,000
2	ye	0,007	0,002	0,008	0,001	0,004
3	gn	0,004	-0,001	0,003	-0,001	0,001
4	rd	0,001	-0,001	0,003	-0,002	0,000
5	vi	0,006	-0,002	0,004	-0,001	0,001
6	wh	0,002	-0,002	0,003	-0,005	-0,002
7	or	0,006	0,002	0,007	0,002	0,003
8	br	0,004	-0,001	0,004	-0,002	-0,001
9	gr	0,003	-0,003	0,004	-0,002	0,000
10	nt	-0,002	-0,003	0,000	-0,004	-0,002
11	pi	0,004	-0,001	0,005	0,000	0,000
12	aq	0,004	-0,007	0,006	-0,001	0,001
13	bl-50-1	-0,001	-0,005	0,004	-0,001	0,000
14	ye-50-1	0,003	0,000	0,003	0,000	-0,001
15	gn-50-1	0,003	-0,004	0,001	-0,004	-0,002
16	rd-50-1	0,006	0,000	0,006	0,000	0,002
17	vi-50-1	0,000	-0,003	0,003	-0,002	-0,001
18	wh-50-1	-0,001	-0,008	0,002	-0,003	0,000
19	or-50-1	0,005	0,001	0,006	0,001	0,003
20	br-50-1	0,004	-0,001	0,003	-0,002	-0,001
21	gr-50-1	0,003	-0,002	0,003	-0,002	0,000
22	nt-50-1	0,000	-0,006	0,002	-0,002	-0,001
23	pi-50-1	0,001	0,000	0,004	-0,002	-0,001
24	aq-50-1	0,001	-0,002	0,004	-0,001	0,001
25	bl-50-2	0,002	-0,007	0,003	-0,002	0,000
26	ye-50-2	0,004	-0,003	0,002	-0,003	0,000
27	gn-50-2	0,004	0,000	0,006	-0,001	0,001
28	rd-50-2	-0,001	-0,002	0,004	0,000	0,001
29	vi-50-2	0,000	-0,005	0,003	-0,003	-0,001
30	wh-50-2	0,003	-0,001	0,004	-0,002	0,000
31	or-50-2	0,000	-0,002	0,003	-0,001	0,001
32	br-50-2	-0,002	0,014	0,002	-0,001	-0,001
33	gr-50-2	0,001	-0,003	0,003	-0,002	0,000
34	nt-50-2	0,001	-0,003	0,002	0,003	0,000
35	pi-50-2	0,007	0,001	0,007	0,002	0,004
36	aq-50-2	0,003	-0,004	0,003	-0,002	-0,001
	min.	-0,002	-0,008	0,000	-0,005	-0,002
	max.	0,007	0,014	0,008	0,003	0,004
	mean	0,002	-0,002	0,004	-0,001	0,000

Handwritten mark

Handwritten mark

Handwritten mark

MOODY INTERNATIONAL

Reviewed
 Witnessed

Date 27.04.2011

Заличено по чл. 36а, ал.3 от ЗОП

temperature cycle test

Typ: ASLH-D(S)B 36 SMF (A20SA 37 - 2,9)
 FA: 10283432
 FL: 6657

VB

attenuation at 1550nm

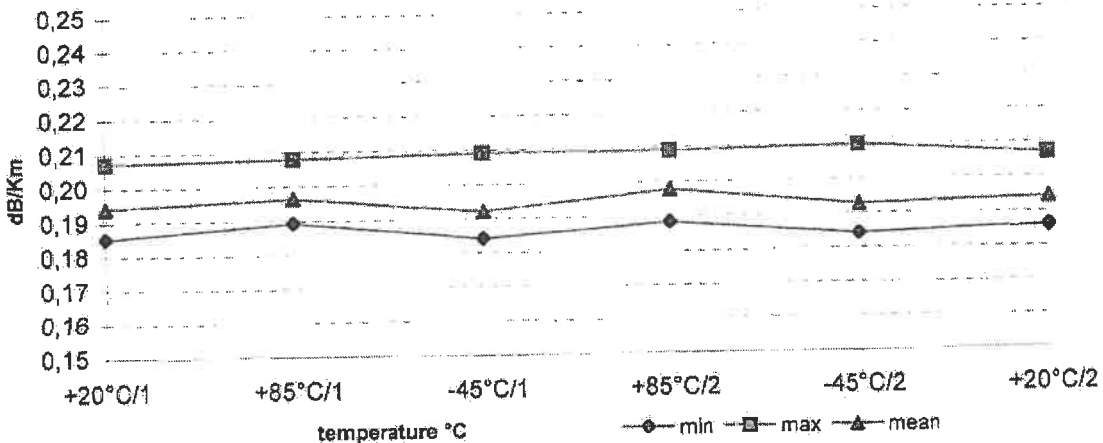

change of attenuation 1550nm

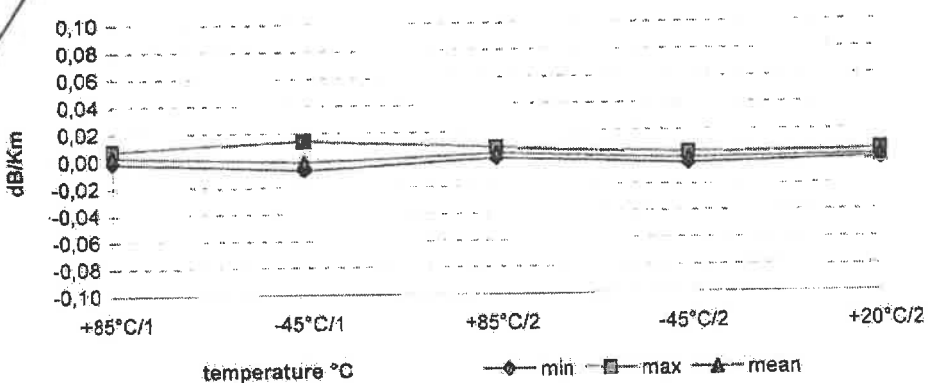

Handwritten signature



MOODY
 INTERNATIONAL
 Reviewed
 Witnessed
 Date: 27.04.05.07.11
 DE - 0079

Handwritten signature

Заличено по чл. 36а, ал.3 от ЗОП



AFL Telecommunications GmbH

Type Test Report

No. TB 2118/11
Date: 05.05.2011
Page: 20

Aeolian Vibration Test

Annex 10

Cable type: ASLH-D(S)B 36 SMF (A20SA 37 - 2.9)
Cable product spec.: TK 10471/10-03
Cable-ID: 10283527/6735
Test procedure: IEC 60794-1-2-E19

Measurement devices: Stabilised light source
Optical Power Meter
OTDR
Aeolian vibration test bench as described in the attached report

Test conditions: length under test: min. 30m
optical length: min. 100m
fibres in a loop: min. 10
test load: 20+/-5% RTS
number of cycles: min. 10⁷
vibration frequency: (830/d +/- 10Hz)

Requirements: increase of att. 1550nm \leq 1,0 dB/test fibre.km
no damage of cable components

Results: increase of att. 1550nm \leq 0,01 dB/test fibre km
no damage of cable components
see test report of independent laboratory

MOODY
INTERNATIONAL

Reviewed
 Witnessed

Date 28.04.11

Заличено по чл. 36а, ал.3 от ЗОП

RIBE

RIBE ELEKTROARMATUREN

Schwabach - Radebeul

Test Report

K 8764e

Title: Aeolian Vibration Test
on Optical Ground Wire
ASLH-D(S)b 36 SMF
(A20SA 37 – 2,9) - dia. 8,6 mm
manufactured by AFL Telecommunications

Type Test

File:
0.61

At the request of: AFL Telecommunications GmbH
Test standard: IEC 60794-1-2-E19 / 10-TMSS-04, rev. 0; 5.1.1e
Request for test No.: 1185
Contents: 16 pages

Summary:

An Aeolian Vibration Test according to IEC 60794-1-2-E19 was carried out in an indoor test span (40 m length) with Optical Ground Wire ASLH-D(S)b 36 SMF (A20SA 37 – 2,9) - dia. 8,6 mm.

Result:

No damage to any component of the cable, nor permanent or temporary increase in optical attenuation greater than 1,0 dB/test fiber km at 1550 nm was observed.

The requirements were fulfilled.

Заличено по чл. 36а, ал.3 от ЗОП

Hans-Jörg Krispin
Head of Engineering

Schwabach, 02 May 2011

Mario Dansachmüller
Senior Engineer

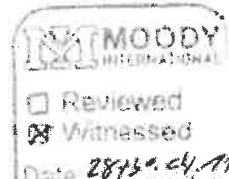

Заличено по чл. 36а, ал.3 от ЗОП

K 8764e

Accreditation:

The quality management system of Richard Bergner Elektroarmaturen GmbH & Co. KG is certified by TÜV NORD CERT GmbH in accordance with DIN EN ISO 9001:2000, certificate registration No. 04 100 950 150.

Adresses:

Manufacturer: AFL Telecommunications GmbH
Bonnenbroicher Str. 2-14
41238 Mönchengladbach, Germany

At the request of: AFL Telecommunications GmbH
Bonnenbroicher Str. 2-14
41238 Mönchengladbach, Germany

Test laboratory: RIBE Test Laboratory
Werk 2
Industriestr. 4
91126 Schwabach, Germany



Заличено по чл. 36а, ал.3 от ЗОП

VB

Contents

	Page
1. Drawing of test sample	Fehler! Textmarke nicht definiert.
2. Description of the test	5
2.1. Test Set-up	5
2.2. Test conditions	6
2.3. Test requirements	6
3. Test results	6
Appendix 1: Diagrams	7
Appendix 2: Photographs	8
Appendix 3: Certificate of Quality Management System	13
Appendix 4: Load cell 200 kN	14
Appendix 5: Non-contact displacement sensor	15
 This report consists of Pages (in total)	 16

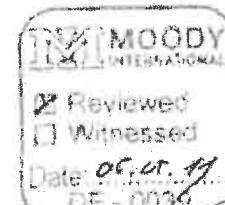
**Заличено по чл. 36а, ал.3 от ЗОП**

VB

1. Cable data sheet



A Fujikura Business

18.10.2018, WS.
120128200300-964216725 TK 10471/0-03

ASLH-D(S)b 36 SMF (A20SA 37 - 2,9)

Optical Ground Wire (OPGW)

according to EN 60794-4 standards

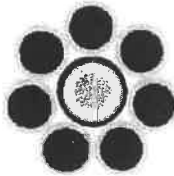

- Stranding direction of outer layer: right hand (Z-stranding)
- Wires acc. to EN 61232
- Maximum fibre capacity per steel tube: 36
- Fibres coloured acc. to colour code system D36 F SEC
- Fibres acc. to G.652
- Impregnated wooden drum with protection

Configuration

Center	1 Stainless Steel Tube with 36 SMF <i>Stainless steel tube material: DIN EN 10088-02, Mat. No 1.4404</i>	2,90 / 3,40 mm
Layer 1	7 A20SA - Wires	2,60 mm

Mechanical Data

Cable Diameter	8,6 mm
Cable Weight	275 kg/km
Supporting Cross Section	37,2 mm ²
Rated Tensile Strength (RTS)	47,3 kN
Ratio RTS / Cable Weight	17,5 km
Modulus of Elasticity	162,0 kN/mm ²
Thermal Elongation Coefficient	13,0 10 ⁻⁶ /K
Permissible Maximum Working Stress (42% RTS)	534,7 N/mm ² (19,9kN)
Recommended Everyday Stress (16% RTS)	203,7 N/mm ² (7,6kN)
Ultimate Exceptional Stress (72% RTS)	916,6 N/mm ² (34,1kN)

Electrical Data

DC Resistance (20°C)	2,325 Ω/km
Conductivity	20,0% IACS
Short Time Current (1,0s, 50-200°C)	2,9 kA
Short Time Current (0,3s, 50-200°C)	5,3 kA
Short Time Current Capacity (Pt (50-200°C)	8,3 kA ² s

Application

Maximum Permissible Installation Force	14,2 kN
Minimum Bending Radius	static: 108 mm dynamic: 129 mm
Normal Delivery Length	4000 m
Temperature Range	Installation: -10 to +50°C Transportation and Operation: -40 to +80°C

All Sizes and Values are Nominal Values
www.aflicie.com

opgw_prob.xls, Rev. 12.02
AFL Telecommunications GmbH

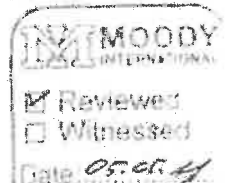

K 8764

Заличено по чл. 36а, ал.3 от ЗОП

2. Description of the test

2.1. Test Set-up

The test arrangement is shown schematically in Figure 1. The photo documentation in Appendix 1 gives details of the test arrangement.

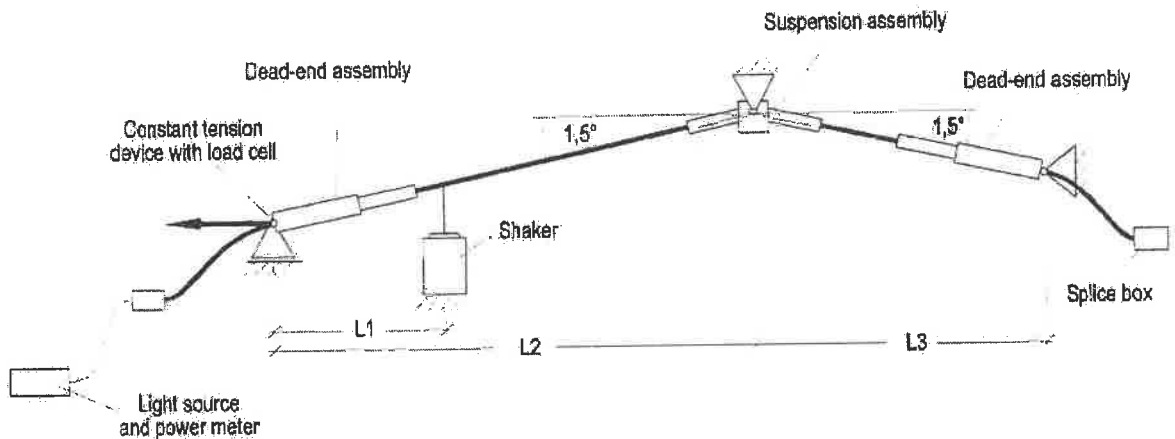

Figure 1: Schematical diagram of test set-up (L1 = 8,54 m, L2 = 28,14 m, L3 = 12,45 m)

The end abutments were used to load and maintain tension in the OPGW. The test section was contained between the two end abutments. The OPGW was cut approx. 5 m beyond the end abutments to allow removal of the cable outer strands and to allow access to the optical fibers.

Tension sets consisting of:

- Thimble for dead end RIBE Drg. No. F 2685/3
- Dead end RIBE Drg. No. AW 140 102
- Protection rods RIBE Drg. No. RW 090 240 lis

were installed on the OPGW to fit between the end abutments. The test sample was terminated at both ends prior to tensioning in a manner such that the optical fibres could not move relative to the cable. This was achieved by an excess length of approximately 5 m OPGW at each span extremity. A calibrated load cell was used to measure cable tension. The cable was tensioned to 9,5 kN (20 % of cable rated tensile strength). An automatically controlled screw-type constant tension device was used to maintain constant tension.

The length of the active span was 28,14 m, with a suspension assembly consisting of:

- Protection rods RIBE Drg. No. UTA 087 240 lis
- Armour grip suspension RIBE Drg. No. LTA 137 180

located approximately two thirds of the distance between the two dead-end assemblies. It was supported at a height such that the static sag angle of the OPGW to horizontal was 1,5° on both sides of the support point.

The mid-loop (antinode) vibration amplitude was measured and monitored with a non-contact optical displacement sensor at a free loop in the active span.

An electronically controlled shaker was used to excite the OPGW in the vertical plane. The shaker armature was securely fastened to the OPGW so that it was perpendicular to the OPGW in the vertical plane. The shaker was located in the span such that 16 free vibration loops built up between the suspension assembly and the shaker.

36 fibers of a total of 36 fibers were spliced in series giving a total fiber test length of 1461,24 m (36 x 40.59 m) between the dead-end assemblies. The power level for the initial optical

RIBE INTERNATIONAL
 Reviewed
 Witnessed
 Date: 28.10.2011
 Stamp: 002
 Documento no. n. 36a, an. 3 of 301

measurement provided a reference level. The difference between the actual power level and the reference level indicated the change in attenuation of the test fibers.

A Stabilized Light Source Anritsu MG9002A with a wave length of 1550 nm was used as light source. The light signal was fed into the OPGW and the optical measurement of the signal after passing the OPGW were made with an Optical Power Meter Anritsu ML 910A. Readings of the optical attenuation were taken every minute during the test.

The measuring equipment was provided by AFL.

Ambient temperature was measured with a thermocouple.

2.2. Test conditions

Specified number of vibration cycles	10 x 10 ⁶
Specified vibration frequency (nearest resonant frequency to $(830/d \pm 10\%)$ Hz (with diameter of cable d=8,6 mm)	96,5 Hz
Actual vibration frequency	90,0 Hz
Actual peak-to-peak amplitude, average	2,87 mm
Total length of the fibers under test	1461,24 m (36 x 40,59 m)
Start of test	28 April 2011, 10 hrs 45

2.3. Test requirements

Any significant damage to any component of the cable, or permanent or temporary increase in optical attenuation greater than 1,0 dB at 1550 nm shall constitute failure.

3. Test results

The test was terminated on 30 April 2011, 9 hours 30 after 15,1 million cycles.

- Variation of optical attenuation during the test was found to be within $\pm 0,01$ dB at 1550 nm. This is well below the specified maximum value of 1,0 dB/test fiber km.
- No mechanical damage to any component of the cable was observed.

The requirements were fulfilled.

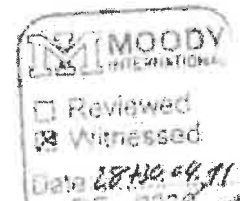

Заличено по чл. 36а, ал.3 от ЗОП

VZ

Appendix 1: Diagrams

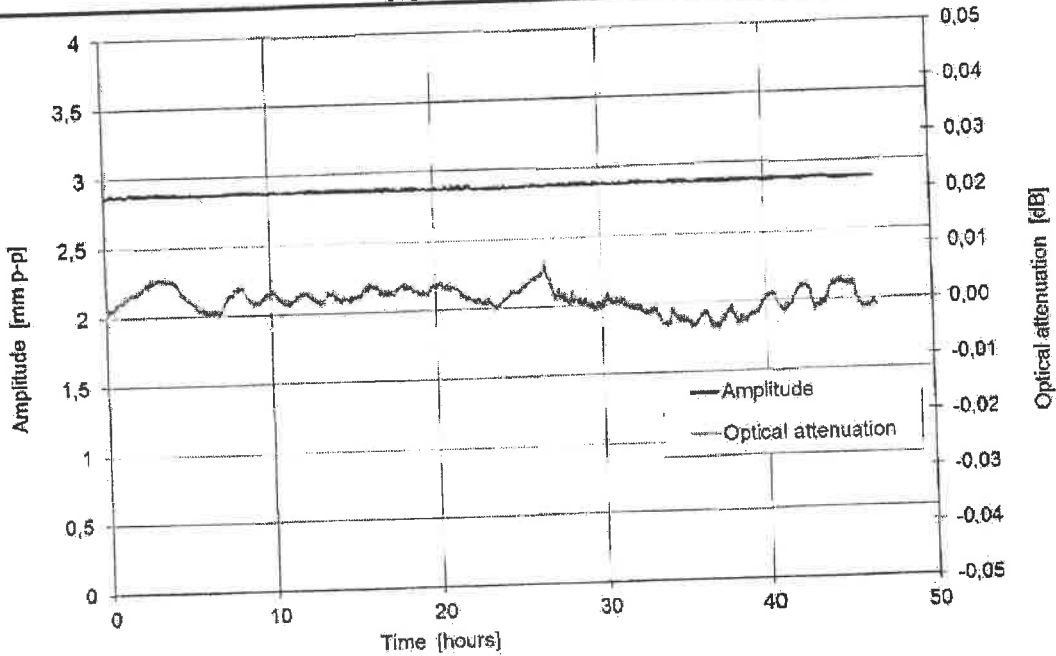

Figure 2: Diagram amplitude and optical attenuation vs time

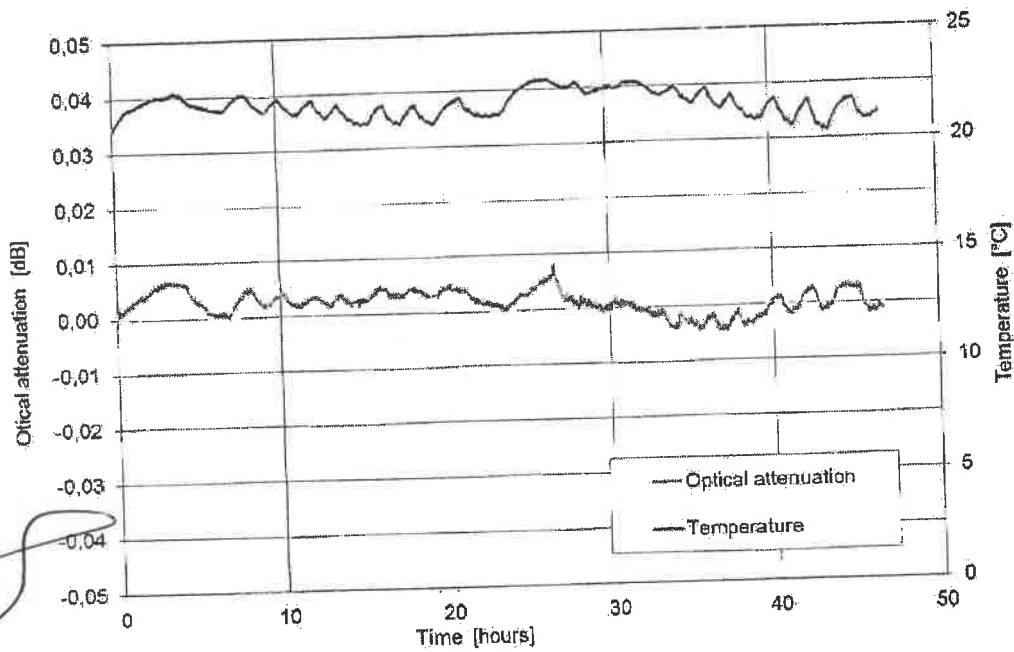

Figure 3: Diagram optical attenuation and ambient temperature vs time

MOODY INTERNATIONAL
 Reviewed
 Witnessed
Date: 28.10.11
11E-1029

Заличено по чл. 36а, ал.3 от ЗОП

V3

Appendix 2: Photographs

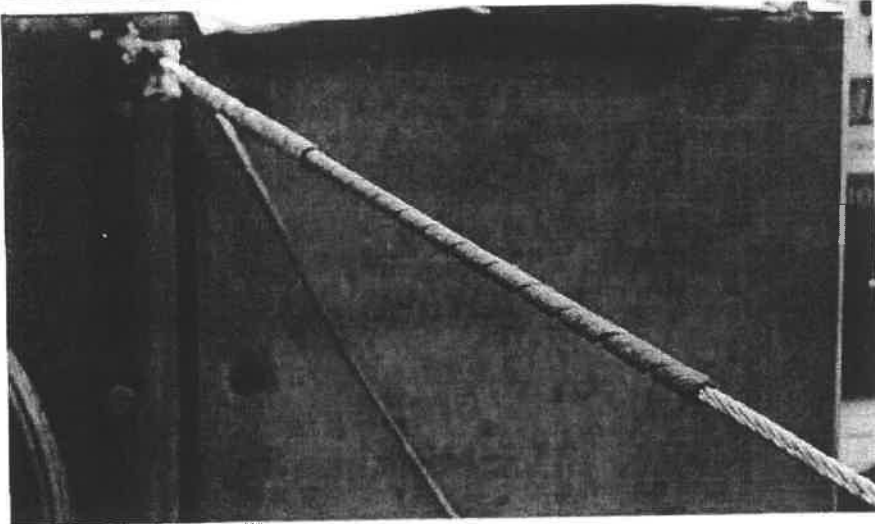

Figure 1: Termination of passive span

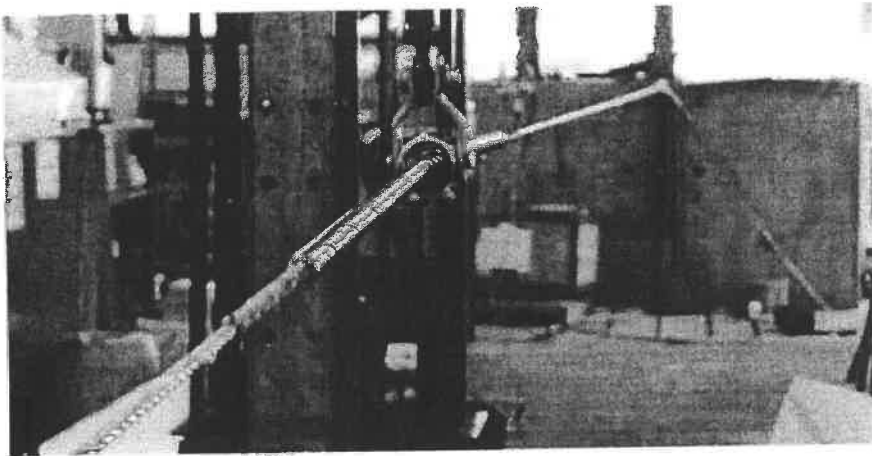

Figure 2: Suspension point, view toward passive span

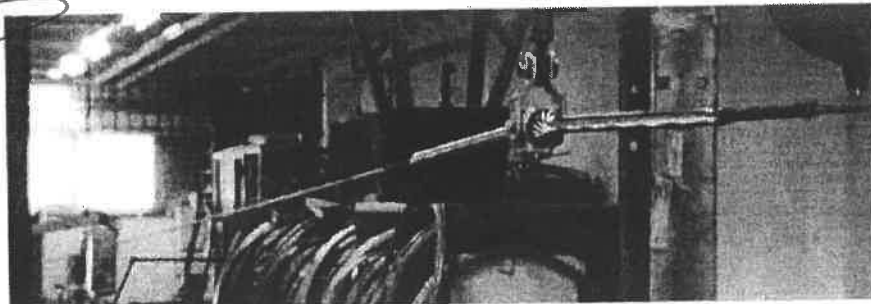

Figure 3: Suspension point, view toward active span

MOODY INTERNATIONAL
 Reviewed
 Witnessed
Date 28.10.04.11
DE 3039

Заличено по чл. 36а, ал.3 от ЗОП

V2

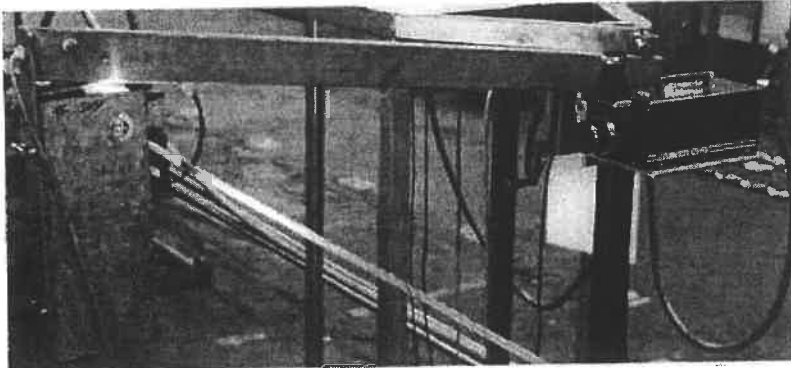

Figure 4: Non-contact optical displacement sensor

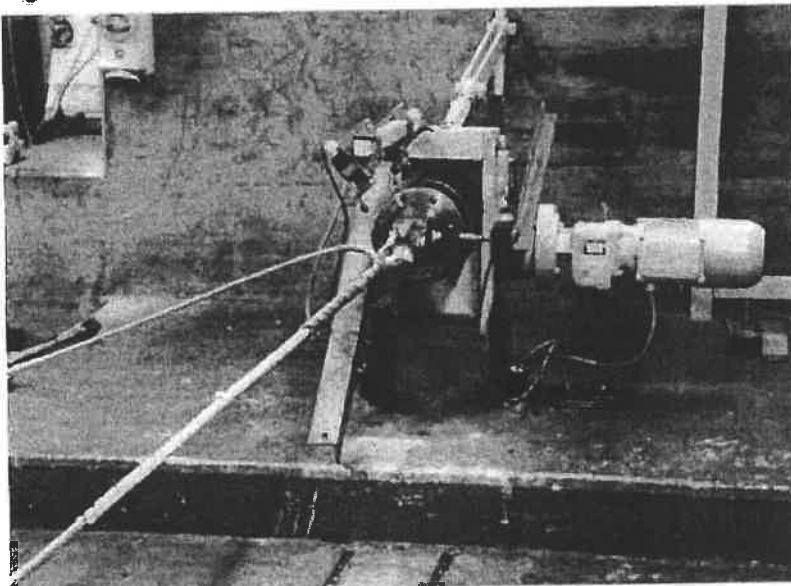

Figure 5: Termination of active span, constant tension device with load cell

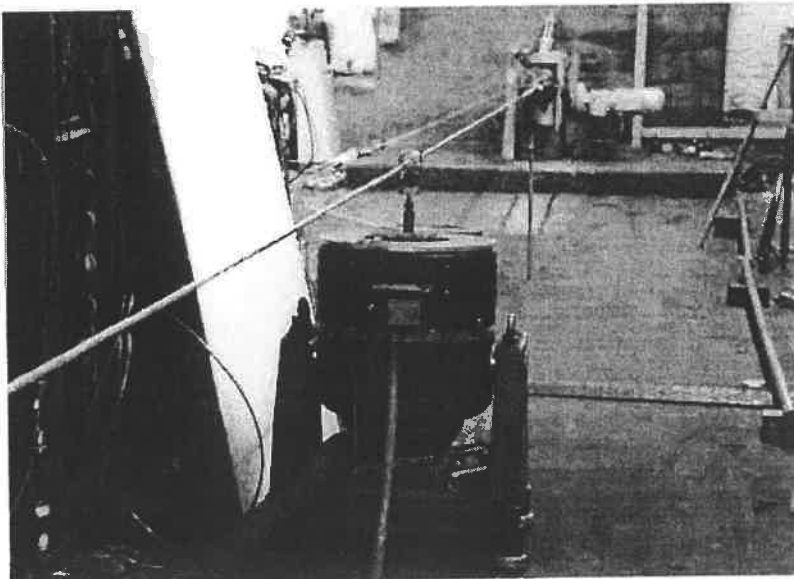

Figure 6: Vibration shaker, view toward constant tension device

Handwritten scribble.

Handwritten checkmark.

MOODY INTERNATIONAL
 Reviewed
 Witnessed
Date: 28 March 11
DE - 0038

Заличено по чл. 36а, ал.3 от ЗОП

Handwritten mark

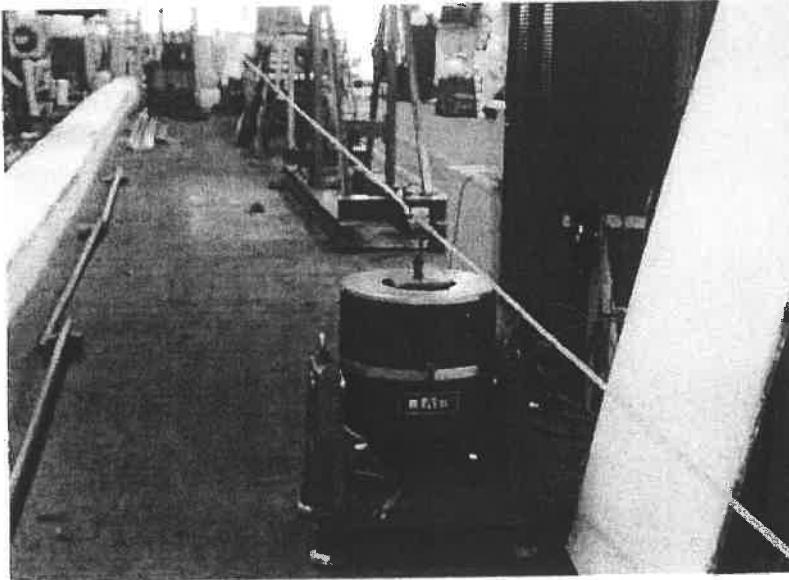

Figure 7: Vibration shaker, view toward constant tension device

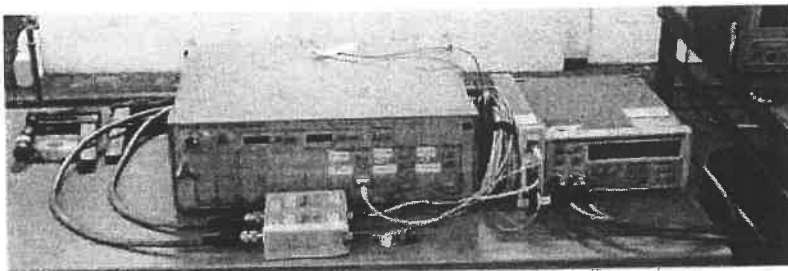

Figure 8: Device for measurement of optical power.

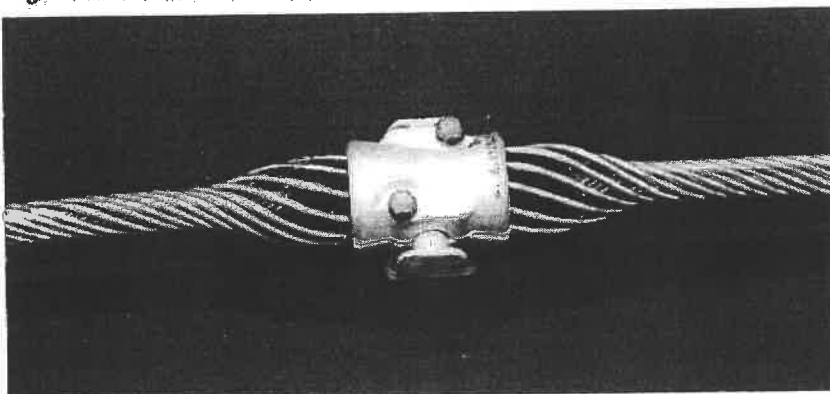

Figure 9: Suspension clamp after test, no damage.

Handwritten mark

MOODY
INTERNATIONAL
 Reviewed
 Witnessed
Date *28.06.11.*
DE - 0039

Заличено по чл. 36а, ал.3 от ЗОП

VZ

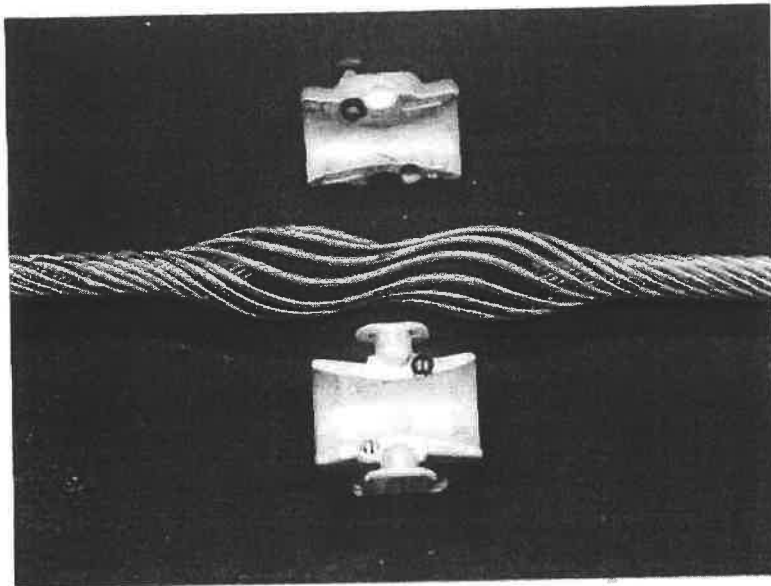

Figure 10: After test, clamp housing taken off, no damage.

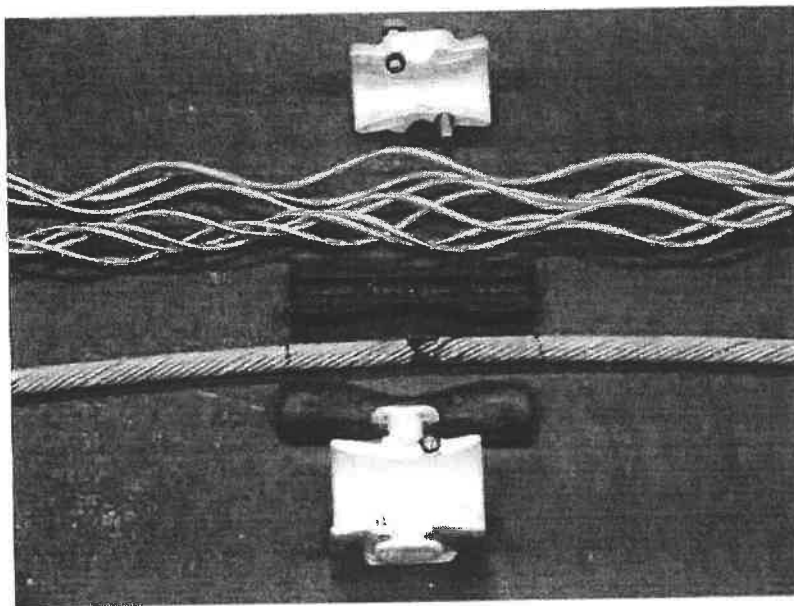

Figure 11: After test, view on protection rods on cable, armour rods and neoprene inserts taken off, no damage.

✓

✓

MOODY INTERNATIONAL
 Reviewed
 Witnessed
Date: 30.04.11

Заличено по чл. 36а, ал.3 от ЗОП

LB

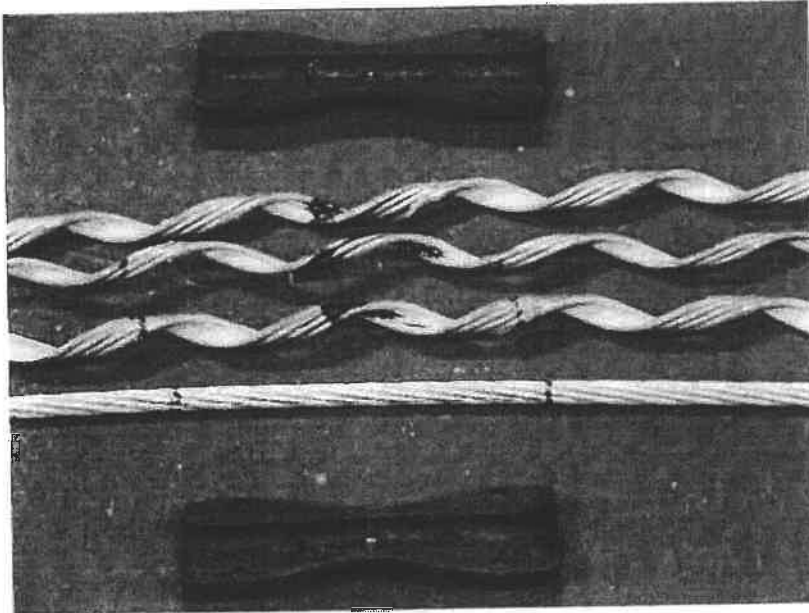

Figure 12: After test, protection rods taken off, view on cable, no damage.

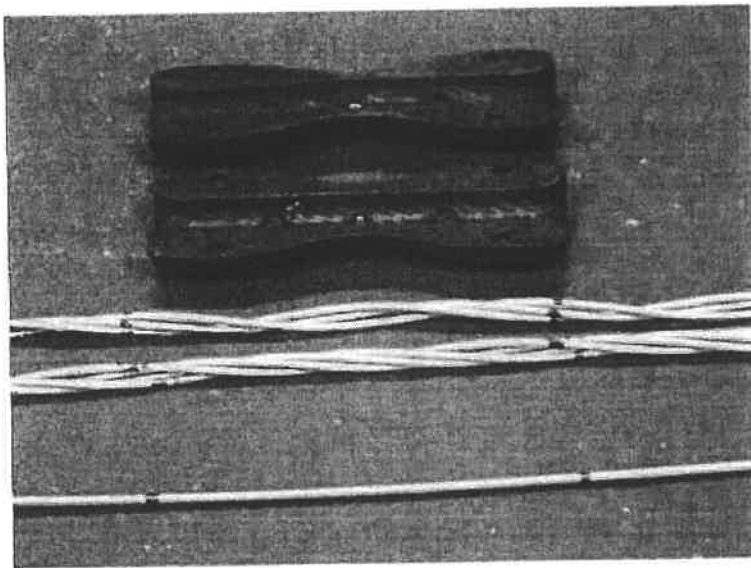

Figure 13: After test, outer wires taken off, view on stainless steel tube (bottom of the picture), no damage.

~

~

MOODY
INTERNATIONAL
 Reviewed
 Witnessed
Date: 30.04.11
DF-0020

Заличено по чл. 36а, ал.3 от ЗОП

13

Appendix 3: Certificate of Quality Management System

CERTIFICATE



Management system as per
DIN EN ISO 9001 : 2008

In accordance with TUV NORD CERT procedures it is hereby certified that:

Richard Bergner Elektroarmaturen GmbH & Co. KG
Bahnhofstraße 8 - 16
91126 Schwabach
Germany

with the places
Schwabach and Radebeul

applies a management system in line with the above standard for the following scope

Fittings and engineering services for electrical power industry,
catenary wire systems, telecommunication appliance and
substation clamps.

Certificate Registration No. 04 100 930150
Audit Report No. 3504-0345

Valid until 2012-07-29
Initial certification 1995

Заличено по чл. 36а, ал.3 от ЗОП

Certification Body
at TUV NORD CERT GmbH

Essen 2009-07-30

This certification was conducted in accordance with the TUV NORD CERT auditing and certification procedures and is
subject to regular surveillance audits.

TUV NORD CERT GmbH

Langenmerzstrasse 20

45144 Essen

www.tuv-nord-cert.com

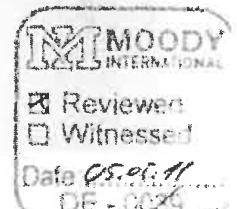

K

Заличено по чл. 36а, ал.3 от ЗОП

Appendix 4: Load cell 200 kN

RIBE

Richard Bergner Elektroarmaturen GmbH + Co. KG

EML

Schwabach den 17.03.2011

Kalibrierschein nach DIN ISO 10012 Teil 1

Kalibrierscheinbezeichnung: Zer101_18 **Seltenanzahl:** 2
 Gültigkeitsdauer: 12 Monate

Die Kalibrierung wurde entsprechend der zugehörigen Arbeitsanweisung "Arb101_3" durchgeführt

Gegenstand der Kalibrierung:

Selbstzugkraftmeßkette des Prüfstandes Sour 2 im Innenraumschwingungsstand, bestehend aus:

Geräte:	Zugkraftaufnehm.;	Meßverstärker;
Type:	K 11;	IMS;
Hersteller:	LORENZ;	LORENZ;
Seriennr.:	28261;	ohne;
Sonstiges:		Kalibrierwert- anzeige

Referenzmeßkette:

Geräte:	Kraftaufnehmer;	Meßverstärker;
Type:	U2A (XM001);	MC55 (AB12);
Hersteller:	HBM;	HBM;
Seriennr.:	F 18511;	ohne;
Genauigkeitskl.	0,1;	Referenzwert- anzeige

Einzelheiten der Referenzmeßkette sind im gültigen Kalibrierschein Nr.: **FL 886 HBM 2009-9** der Firma HBM vom 07.09.2009 beschrieben, die Kalibrierung ist im Sinne der DIN EN ISO 9001 und DIN ISO 10012, Teil 1 auf nationale Normale rückführbar.

Meßwerte: siehe Rückseite **Prüfdatum:** 09.03.2011

Prüfer: Jung / Heini

Unterschrift:

Заличено по чл. 36а,
ал.3 от ЗОП

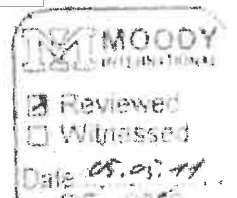

Appendix 5: Non-contact displacement sensor

RIBE

Richard Bergner Elektroarmaturen GmbH + Co. KG

EKL

Schwabach den 02.08.2010

Kalibrierschein nach DIN ISO 10012 Teil 1

Kalibrierscheinbezeichnung: Zert_Opt25 Seitenanzahl: 2

Die Kalibrierung wurde entsprechend der zugehörigen Arbeitsanweisung "Arba 9/5." durchgeführt.

Gegenstand der Kalibrierung: Elektro-optische Wegmeßer Meßbereich +/- 25 mm, im Innenraumschwingungsstand.

Geräte:	Hersteller:
Geräte:	Wegmesser:
Type:	Ysaron
	100B / 101B:
Hersteller:	Rodénstock:
	Zimmer:
Seriennr.:	100-5 / 1270

Referenzmeßkette:

Geräte:	Hersteller:	Type:	Seriennr.:	Sonstiges:	Gültiger Kalibrierschein:
a - Aufnehmer	Kistler	8702B25M1	C192799	-	857/2010
Analysator	Hewlett&Packard	35665 A	3046 A 00173	Prog.-gesteuert	1-240133/431-1
Kal. Programm	RIBE-	Kalib_25_Opt		Referenzanz.	

Einzelheiten der Referenzmeßkette sind in den aufgeführten Kalibrierscheinen beschrieben.

Meßwerte: siehe Rückseite

Prüfdatum: 02.08.2010

Prüfer: Krispin / Jung

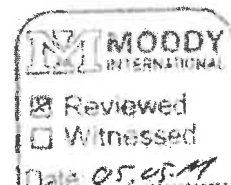

Заличено по чл. 36а, ал.3 от ЗОП

VB

RIBE

RIBE Test Laboratory

Test Report K 8764e

Page 16

Richard Bergner Elektroarmaturen GmbH & Co. KG is certified by TÜV NORD CERT GmbH in accordance with DIN EN ISO 9001, certificate registration No. 04 100 950 150.

A quality management system in accordance with DIN EN ISO 9001 ensures a continuous inspection of measuring and test equipment. Reference standards traceable to national standards are available.

Richard Bergner Elektroarmaturen GmbH & Co. KG is a certified supplier of the Chinese „Ministry of Railways“ (MoR).

Richard Bergner Elektroarmaturen GmbH & Co. KG is an authorized supplier by Sellihoa Nordic Utility Pre-Qualification System with registration No.101109.

Richard Bergner Elektroarmaturen GmbH & Co. KG is an authorized supplier of ADWEA, PCGIL and ESKOM.

Richard Bergner Elektroarmaturen GmbH & Co. KG is an authorized supplier of E.ON AG, RWE AG and Vattenfall Europe AG for high voltage OHTL fittings, fittings for fibre optic cables and for damping systems.

Richard Bergner Elektroarmaturen GmbH & Co. KG is an authorized supplier of Deutsche Bahn AG, Nederlandse Spoorwegen and Österreichischen Bundesbahnen AG.

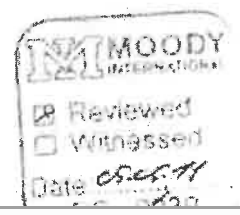

K 8764e

Заличено по чл. 36а, ал.3 от ЗОП

RIBE

VB

RIBE ELEKTROARMATUREN

Schwabach - Radebeul

Schwabach, 28 April 2011

PROTOCOL

Termination of test on OPGW

At the request of: **AFL Telecommunications GmbH**
 Project: **Saudi Electricity Company SEC**
Saudi Arabia

The following test:

Test	OPGW
Aeolian Vibration Test	ASLH-D(S)b 36 SMF (A20SA 37 - 2,9)

was started in the presence of the persons named below.

The test procedure was found to be in order. The test results will be documented in a final detailed report.

- Mr Saeed Hamad Al Kahtani / SEC
- Mr Majid Abdulrahman Al Suhibani /
- Mr Abdulaziz Abdulrahman Al Hagba
- Mr Norbert Zimmermann / Moody
- Mr Heribert Mühlen / AFL
- Mr Carl-Magnus Kyrklund / AFL

**Заличено по чл. 36а,
ал.3 от ЗОП**

Dr. Mario Darisachmüller / RIBE

Заличено по чл. 36а, ал.3 от ЗОП

Annexes

Annex 1	Aeolian Vibration Test.....	2
Annex 2	ISO 9001 Certificate.....	3
Annex 3	Load cell 200 kN.....	4
Annex 4	Electro-optic displacement sensor.....	7

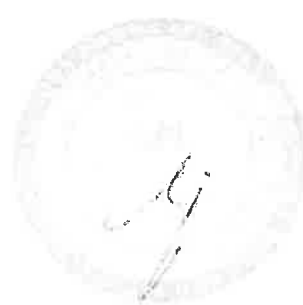

Protocol

Annex 1 Aeolian Vibration Test

Test standard: IEC 60794-1-2-E19:2003 / 10-TMSS-04, rev. 0; 5.1.1e

Measurement devices: Load cell 200 kN, Lorenz K11, S. No. 28261
(calibration certificate see annex 3)
Optical Power Meter Anritsu ML 910A

Test requirements: Increase of attenuation 1550 nm \leq 1,0 dB/test fibre km; no damage of cable components.

Annex 2 ISO 9001 Certificate

CERTIFICATE



Management system as per
DIN EN ISO 9001 : 2008

In accordance with TUV NORD CERT procedures, it is hereby certified that

Richard Bergner Elektroarmaturen GmbH & Co. KG
Bahnhofstraße 8 - 16
91126 Schwabach
Germany

with the places
Schwabach and Radebeul

operation management system in accordance with the applicable standard for the following activities

**Fittings and engineering services for electrical power industry,
catenary wire systems, telecommunication appliance and
substation clamps**

Certificate Registration No. 04 100 050150
Award Report No. 1004 0149

Valid until 2012-07-25
Certificate No. 1100

Заличено по чл. 36а, ал.3 от ЗОП

Certificate No. 1100
© TUV NORD CERT GmbH

Expiry: 2009-07-30

This certificate was issued under agreement with the TUV NORD CERT and the applicable standard for the following activities

TUV NORD CERT GmbH

Leipzig, September 27

45111 0000

www.tuv-nord.com



1100 2009-07-30

Annex 3 Load cell 200 kN

RIBE

Richard Bergner Elektroarmaturen GmbH + Co. KG

EML

Schwabach den 17.03.2011

Kalibrierschein nach DIN ISO 10012 Teil 1

Kalibrierscheinbezeichnung: Zer101_18 Serienanzahl: 2
 Gültigkeitsdauer: 12 Monate

Die Kalibrierung wurde entsprechend der zugehörigen Arbeitsanweisung "Arb101_3" durchgeführt

Gegenstand der Kalibrierung:

Seilzugkraftmeßkette des Prüfstandes Spur 2 im Innenraumschwingungsstand, bestehend aus:

Geräte:	Zugkraftaufnehm.;	Meßverstärker;
Type:	K 11;	IMS;
Hersteller:	LORENZ;	LORENZ;
Seriennr.:	28261;	ohne;
Sonstiges:		Kalibrierwert- anzeige

Referenzmeßkette:

Geräte:	Kraftaufnehmer;	Meßverstärker;
Type:	U2A (XM001);	MC55 (AB12);
Hersteller:	HBM;	HBM;
Seriennr.:	F 18511;	ohne;
Genauigkeitskl.:	0,1;	Referenzwert- anzeige

Einzelheiten der Referenzmeßkette sind im gültigen Kalibrierschein Nr.: FL 886 HBM 2009-9 der Firma HBM vom 07.09.2009 beschrieben, die Kalibrierung ist im Sinne der DIN EN ISO 9001 und DIN ISO 10012, Teil 1 auf nationale Normale rückführbar.

Meßwerte: siehe Rückseite

Prüfdatum: 09.03.2011

Prüfer: Jung / Heirl

Unterschrift:

Заличено по чл. 36а,
ал.3 от ЗОП

RIBE

Richard Bergner Elektroarmaturen GmbH + Co. KG

Seite 2 zum Prüfzeugnis vom 09.03.2011

Meßwerte untarziert mit dem Kalibrierwerten 63 und 9655 gemessen:

Referenzwertanzeige [kN]	Kalibrierwertanzeige			
	steigend [kN]	Abweichung [%]	fallend [kN]	Abweichung [%]
0	0,00	0,00	0,00	0,00
5	5,00	0,00	4,98	-0,40
10	9,90	-1,00	9,90	-1,00
20	19,84	-0,80	19,86	-0,70
30	29,84	-0,53	29,86	-0,47
40	39,90	-0,25	39,88	-0,30
50	49,86	-0,28	49,86	-0,28
60	59,92	-0,13	59,90	-0,17
70	69,90	-0,14	69,98	-0,03
80	79,96	-0,05	80,00	0,00
90	90,00	0,00	90,12	0,13
100	100,30	0,30	99,98	-0,02
Belastung mit Umgebung	Seil-Ø 20[mm] 21		Seil-Ø 20[mm] 21	
Abweichung vom Kalibrierendwert		-0,16		-0,14
zul. Fehlergrenze		± 1,00		± 1,00

Bei zukünftigen Messungen sind die neuen Kalibrierwerte 63 und 9655 zu benutzen.

RIBE Richard Bergner Elektroarmaturen GmbH + Co. KG

zu Kalibrierschein: Zer101_18
Seite 3 zum Prüfzeugnis vom 09.03.2011

Meßwerte unterteilt mit dem Kalibrierwerten 63 und 9655 gemessen:

Spiderein- stellung		Kanal 1 100 Hz	Spannung 10 V Filter Variable bester Zeitverlauf 10 Hz Verstärker 0.002 mV/V		Delphin-Gerät 10V = 200 kN			
Spider steigend	Abweichung [%]	Spider fallend	Abweichung [%]	Delphin steigend	Abweichung [%]	Delphin fallend	Abweichung [%]	
0,00	0	0	0	0		0,06		
5,05	1,00	5,05	1,00	5,02	0,40	5,01	0,20	
10,02	0,20	10,064	0,64	9,99	-0,10	10,04	0,40	
20,04	0,20	20,152	0,76	19,98	-0,10	20,11	0,55	
30,12	0,40	30,136	0,45	29,95	-0,17	30,13	0,43	
40,1	0,25	40,16	0,40	39,95	-0,13	40,13	0,33	
50	0,00	50,176	0,35	49,9	-0,20	50,09	0,18	
60,05	0,08	60,184	0,31	59,95	-0,08	60,28	0,43	
70,05	0,07	70,184	0,26	69,95	-0,07	70,24	0,34	
80,1	0,12	80,28	0,35	79,96	-0,05	80,27	0,34	
90,1	0,11	90,376	0,42	90,06	0,06	90,35	0,39	
100,466	0,46	100,56	0,56	100,3	0,30	100,45	0,45	
St-Seil-Ø 20(mm)		St-Seil-Ø 20(mm)		St-Seil-Ø 20(mm)				
21		21				21		
	0,00		0,00		-0,10		0,01	
	0,00		0,56		0,30		0,45	
	± 1,00		± 1,00		± 1,00		± 1,00	

Bei zukünftigen Messungen sind die neuen Kalibrierwerte 63 und 9655 zu benutzen.

Zer101_18

Annex 4 Electro-optic displacement sensor

RIBE

Richard Bergner Elektroarmaturen GmbH + Co. KG

EKL

Schwabach den 02.08.2010

Kalibrierschein nach DIN ISO 10012 Teil 1

Kalibrierscheinbezeichnung: Zert_Opt25 Seitenanzahl: 2

Die Kalibrierung wurde entsprechend der zugehörigen Arbeitsanweisung "Arba..." durchgeführt.

Gegenstand der Kalibrierung: Elektro-optische Wegmeßer Meßbereich +/- 25 mm.
im Innenraumschwingungsstand.

Geräte:	Hersteller:
Geräte:	Wegmesser;
Type:	Ysaron
	100B / 101B;
Hersteller:	Rodenstock;
	Zimmer;
Seriennr.:	100-5 / 1270

Referenzmeßkette:

Geräte:	Hersteller:	Type:	Seriennr.:	Sonstiges:	Gültiger Kalibrierschein:
a - Aufnehmer	Kistler	8702B25M1	C192799	-	857/2010
Analysator	Hewlett&Packard	35865 A	3046 A 00173	Prog.-gesteuert	1-2401338431-1
Kal. Programm	RIBE-	Kalib_25_Opt		Referenzanz.	

Einzelheiten der Referenzmeßkette sind in den aufgeführten Kalibrierscheinen beschrieben.

Meßwerte: siehe Rückseite

Prüfdatum: 02.08.2010

Prüfer: Krispin / Jung

Заличено по чл. 36а,
ал.3 от ЗОП

Electro-optic displacement sensor: calibration measurement data

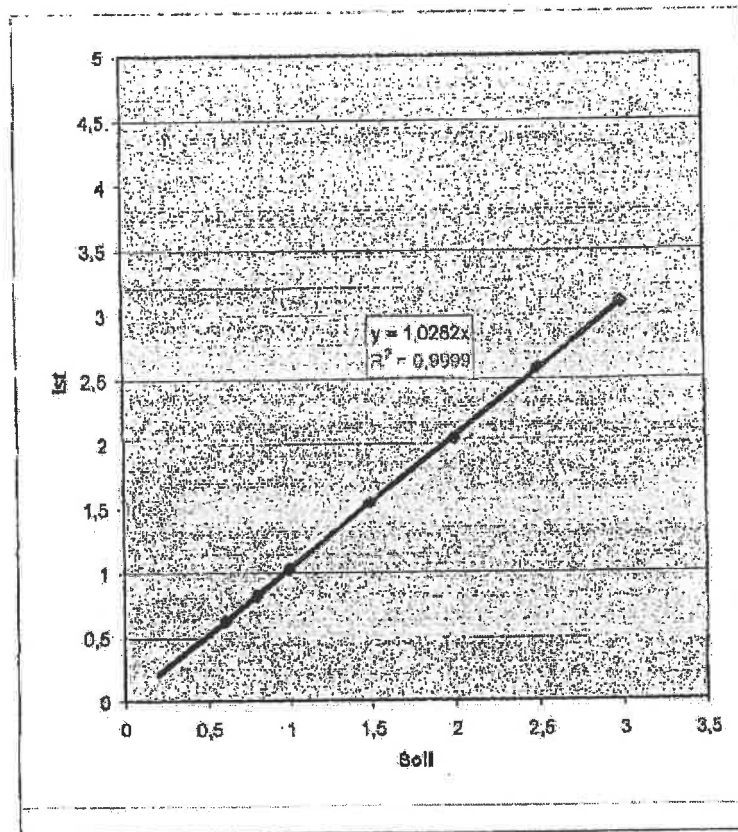

f	50	Hz			
Weg Soll [mm]	Beschleunigung Soll [m/s²]	Beschleunigung Ist [m/s²]	Weg soll [mm]	Weg Ist [mm]	Weg * Faktor [mm]
0,2					
0,4					
0,6	59,22	59,18	0,600	0,617	0,610
0,8	78,96	78,66	0,797	0,819	0,810
1,0	98,70	98,52	0,998	1,027	1,016
1,5	148,04	147,52	1,495	1,540	1,523
2,0	197,39	197,07	1,997	2,040	2,018
2,5	246,74	246,23	2,495	2,650	2,552
3,0	296,08	295,48	2,993	3,090	3,056

Optik 26 Filterfrequenz 1 k

Faktor: 0,989

Zukünftig Ist mit den Kalibrierfaktor 0,989 zuarbeiten



AFL Telecommunications GmbH

Type Test Report

No. TB 2118/11
Date: 05.05.2011
Page: 21

Creep Test

Annex 11

Cable type: ASLH-D(S)B 36 SMF (A20SA 37 - 2,9)
Cable product spec.: TK 10471/10-03
Cable-ID: 10283527/6735
Test procedure: IEC 61395

Measurement devices: Creep Test bench

Test conditions: test length: min. 10m
 test load: 30% RTS
 test duration: min. 1000h

Requirements: (record of strain vs. time)

Results: strain vs. time was recorded
 see report of independent laboratory
 (400h under test; test is continuing up to 1400h)

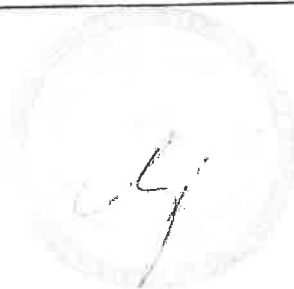

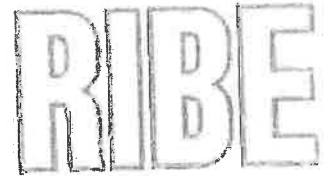

RIBE ELEKTROARMATUREN

Schwabach - Radebeul

Schwabach, 28 April 2011

PROTOCOL

Termination of test on OPGW

At the request of: **AFL Telecommunications GmbH**
 Project: **Saudi Electricity Company SEC**
Saudi Arabia

The following test:

Test	OPGW
Creep Test	ASLH-D(S)b 36 SMF (A20SA 37 – 2,9)

was inspected in the presence of the persons named below.

The test procedure and the preliminary results were found to be in order. The test was decided to run for another 1000 h from the time of inspection. The test results will be documented in a final detailed report.

- Mr Saeed Hamad Al Kahtani / SEC
- Mr Majid Abdulrahman Al Suhibani / SEC
- Mr Abdulaziz Abdulrahman Al Hagbani / SEC
- Mr Norbert Zimmermann / Moody
- Mr Heribert Mühlen / AFL
- Mr Carl-Magnus Kyrklund / AFL

**Заличено по чл. 36а,
ал.3 от ЗОП**

Dr. Mario Dansachmüller / RIBE

Заличено по чл. 36а, ал.3 от ЗОП

Annexes

Annex 1	Creep Test.....	2
Annex 2	ISO 9001 Certificate.....	3
Annex 3	Load cell 100 kN.....	4
Annex 4	Displacement sensors.....	7

Annex 1 Creep Test

Test standard: IEC 61395:1998 (30% RTS;1000h)/ 10-TMSS-04, rev. 0; 5.1.1h

Measurement devices: Load cell 100 kN, Lorenz K11, S. No. 48070
(calibration certificate see Annex 3)
Displacement sensor HBM WA 50 mm, S. No. 82810077
Displacement sensor HBM WA 20 mm, S. No. 34910147
(calibration certificate see Annex 4)

Test requirements: A linear regression shall be made using the values between 1 h and 1000 h to calculate the creep equation.
The constants a and b shall be presented in the report, together with nominal agreed temperature variation. A log-log diagram shall be made with elongation versus time up to 100000 h with the fitted straight line plotted together with the nominal and average temperatures and actual temperature variation

Protocol

Annex 2 ISO 9001 Certificate

CERTIFICATE

TUV NORD

Management system as per
DIN EN ISO 9001 : 2008

In accordance with TUV NORD CERT procedures it is hereby certified that

Richard Bergner Elektroarmaturen GmbH & Co. KG
Bahnhofstraße 8 - 16
91126 Schwabach
Germany

with the places
Schwabach and Radebeul

with the following description of the activities and for the following scope

**Fittings and engineering services for electrical power industry,
catenary wire systems, telecommunication appliance and
substation clamps**

Certificate Registration No. 01 141 804130
April 2008 No. 110401016

Valid until 21.12.07-23
for certificate 000

Заличено по чл. 36а, ал.3 от ЗОП

CE: [unclear] Bush
at TUV NORD CERT GmbH

Issue: 7000-07-03

This certificate is valid only for the activities listed in the TUV NORD CERT registration and is not to be used for other purposes.

TUV NORD CERT GmbH

Leipzig, Germany

10741 0000

www.tuv-nord.com



Annex 4 Load cell 100 kN

RIBE

Richard Bergner Elektroarmaturen GmbH + Co. KG

EKL

Schwabach den 09.03.2011

Kalibrierschein nach DIN ISO 10012 Teil 1

Kalibrierscheinbezeichnung: Zer102_18 Seitenanzahl: 2
 Gültigkeitsdauer: 12 Monate

Die Kalibrierung wurde entsprechend der zugehörigen Arbeitsanweisung "Arb102_2" ausgeführt.

Gegenstand der Kalibrierung:

Seilzugkraftmeßkette des Prüfstandes Spur 3 im Innenraumschwingungsstand, bestehend aus:

Geräte:	Zugkraftaufnehm.;	Meßverstärker;
Type:	K11;	PAX S;
Hersteller:	LORENZ;	LORENZ;
Seriennr.:	48070;	7524;
Sonstiges:		Kalibrierwert- anzeige

Referenzmeßkette:

Geräte:	Kraftaufnehmer;	Meßverstärker;
Type:	U2A (XM001);	MC65 (AB12);
Hersteller:	HBM;	HBM;
Seriennr.:	F 18511;	ohne;
Genauigkeitskf.:	0,1;	Referenzwert- anzeige

Einzelheiten der Referenzmeßkette sind im gültigen Kalibrierschein Nr.: FL885 HBM 2009-09 der Firma HBM vom 2009-09-07 beschrieben, die Kalibrierung ist im Sinne der DIN EN ISO 9001 und DIN ISO 10012, Teil 1 auf nationale Normale rückführbar.

Meßwerte: siehe Rückseite Prüfdatum: 09.03.2011

Prüfer: Jung / Hehl Unterschrift:

Заличено по чл. 36а,
ал.3 от ЗОП

Annex 5 Electro-mechanical displacement sensors

RIBE

Richard Bergner Elektroarmaturen GmbH + Co KG

EKL

Schwabach, den 21.03.2011

Kalibrierschein nach DIN ISO 10012 Teil 1

Kalibrierscheinbezeichnung: Zert125_18 Seitenanzahl: 3
 Gültigkeitsdauer: 12 Monate

Die Kalibrierung wurde entsprechend der Arbeitsanweisung " 126/1 " durchgeführt.

Gegenstand der Kalibrierung: Beide Wegtaster für getrennte Wegmessungen,
 Taster B mit 25[m] Verlängerungskabel.

Meßkette für Kriechdehnungsmessungen an Seilen und Kabeln bis 200[kN], bestehend aus:

Geräte:	Wegtaster A	Wegtaster B	Verstärker
Type:	WA 50 mm	WA 20 mm	SPIDER
Hersteller:	HBM	HBM	HBM
Serienr.:	82810077	40710321	-
Genauigkeitskl.:	0,1	0,1	0,1
Sonstiges:	6-Leiter	6-Leiter	

Referenzmaße:

Geräte:	Endmaßsatz	Haltevorrichtung
Typo:	-	-
Hersteller:	C.Johansson	RIBE
Serienr.:	11	-
Genauigkeitskl.:	1 bei 20°	-
Sonstiges:	DKD - 17301	-

Einzelheiten der Referenzendmaße sind im gültigen Kalibrierschein vom 21.6.2005 beschrieben. Die Kalibrierung ist im Sinne der DIN EN ISO9001 und DIN ISO 10012, Teil 1 auf nationale Normale rückführbar.

Meßwerte: siehe Rückseite

Prüfdatum: 21.03.2011

Prüfer: Jung / Heini

Заличено по чл. 36а, ал.3 от ЗОП

Unterschrift: 

RIBE

RIBE ELEKTROARMATUREN

Schwabach - Radebeul

Test Report

VE-K 8786e

Devices under Test: Creep Test
on Optical Ground Wire
ASLH-D(S)b 36 SMF
(A20SA 37 – 2,9) - dia. 8,6 mm
manufactured by AFL Telecommunications

Creep Test

File: 1.7

Client: AFL Telecommunications GmbH

Applied Specification: IEC 61395 / 10-TMSS-04, rev. 0; 5.1.1h

Contents: 13 pages

Summary:

According IEC 61395 a creep test with an ASLH-D(S)b 36 SMF (A20SA 37 – 2,9) - dia. 8,6 mm was carried out.

Result:

The creep behavior of the conductor was determined as

$$\epsilon_c = 0.00703187 \times t^{0.158667},$$

where ϵ_c is the creep strain in % and t is time in hours.

The calculated long time creep for ten years (=87600 hours) is 0.0428 %.

Заличено по чл. 36а, ал.3 от ЗОП

Stefan Halbig
Development Engineer

Mario Dansachmüller
Test Engineer

Schwabach, 15th June, 2011

The test results relate exclusively to the items tested.
This document shall not be reproduced except in full without
the written approval of Richard Bergner Elektroarmaturen GmbH & Co. KG

Reviewed
 Witnessed

Date: 28.04.15.06.11

DF - 0039

Заличено по чл. 36а,
ал.3 от ЗОП

VE-K 8786e

13

Accreditation:

The quality management system of Richard Bergner Elektroarmaturen GmbH & Co. KG is certified by TÜV NORD CERT GmbH in accordance with DIN EN ISO 9001:2008, certificate registration No. 04 100 950 150.

Addresses:

Manufacturer: AFL Telecommunications GmbH
Bonnenbroicher Str. 2-14
41238 Mönchengladbach, Germany

Customer: AFL Telecommunications GmbH
Bonnenbroicher Str. 2-14
41238 Mönchengladbach, Germany

Test laboratory: RIBE Test Laboratory
Werk 2
Industriestr. 4
91126 Schwabach, Germany

VE-K 8786e

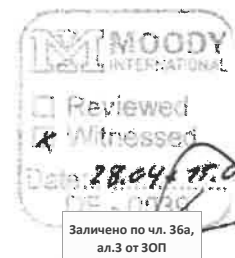

Заличено по чл. 36а,
ал.3 от ЗОП

Contents

	Page
1. Drawings	4
2. Description of the test and results	5
2.1. Set-up for the Creep Test	5
2.2. Start-end of test	5
2.3. Results of the Creep Test	6
3. Annex: Certificates	10
3.1. ISO 9001 certificate	10
3.2. Load cell 100 kN	11
3.3. Displacement sensors	12

**This report consists of
Pages (in total)**

MOODY
INTERNATIONAL

Reviewed
 Witnessed

Date **28.04.15.06.M**

13

Заличено по чл. 36а,
ал.3 от ЗОП

1. Drawings



A Fujikura Business

18.10.2010, WS,
120128208300 05421672S TK 10471/10-03

ASTA 015 0000000007 20

Optical Ground Wire (OPGW)

according to EN 60784-3 standards



- Stranding direction of outer layer: right hand (Z-stranding)
- Wires acc. to EN 61232
- Maximum fibre capacity per steel tube: 36
- Fibres coloured acc. to colour code system 036 F SEC
- Fibres acc. to G.652
- Impregnated wooden drum with protection

Configuration

Center	1 Stainless Steel Tube with 36 SMF <i>Stainless steel tube material: DIN EN 10088-02, Mat. No. 1.4404</i>	2,90 / 3,40 mm
Layer 1	7 A20SA - Wires	2,60 mm

Mechanical Data

Cable Diameter	8,6 mm
Cable Weight	275 kg/km
Supporting Cross Section	37,2 mm ²
Rated Tensile Strength (RTS)	47,3 kN
Ratio RTS / Cable Weight	17,5 km
Modulus of Elasticity	162,0 kN/mm ²
Thermal Elongation Coefficient	13,0 10 ⁻⁶ /K
Permissible Maximum Working Stress (42% RTS)	534,7 N/mm ² (19,9kN)
Recommended Everyday Stress (16% RTS)	203,7 N/mm ² (7,6kN)
Ultimate Exceptional Stress (72% RTS)	916,6 N/mm ² (34,1kN)

Electrical Data

DC Resistance (20°C)	2,325 Ω/km
Conductivity	20,0% IACS
Short Time Current (1,0s, 50-200°C)	2,9 kA
Short Time Current (0,3s, 50-200°C)	5,3 kA
Short Time Current Capacity I ² t (50-200°C)	8,3 kA ² s

Application

Maximum Permissible Installation Force	14,2 kN
Minimum Bending Radius	static: 108 mm dynamic: 129 mm
Normal Delivery Length	4000 m
Temperature Range	Installation: -10 to +50°C Transportation and Operation: -40 to +80°C

All Sizes and Values are Nominal Values
www.aftele.com

opgw_pro8.xls, Rev. 12.02
AFL Telecommunications GmbH

MOODY INTERNATIONAL

Reviewed

Witnessed

Date: 28.04.15.06.09

Заличено по чл. 36а,
ал.3 от ЗОП

2. Description of the test and results

2.1. Set-up for the Creep Test

Figure 1 shows the general test arrangement.

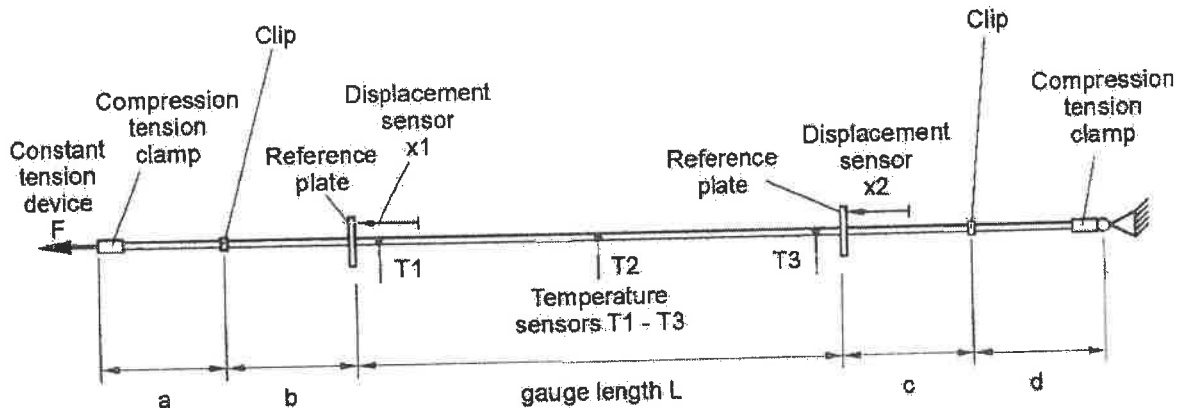

Sample length: 40.63 m
 Gauge length L: 30.06 m
 a / d 2.72 m / 2.67 m
 b / c 2.49 m / 2.51 m

Figure 1: Arrangement of the Creep Test

Compression type end fittings were used. Additionally, bolted clips were applied to prevent slippage and interlayer movement. The grooves of the clips had the same diameter as the cable to keep the sample perfectly concentric.

Displacements x_1 and x_2 were measured with two inductive displacement sensors (LVDT - Linear Variable Differential Transformer, measurement range 20 mm and 50 mm, accuracy 0.2 %). Total strain was determined as $\epsilon_{total} = (x_1 - x_2)/L$, with gauge length L.

The conductor temperature was measured in the middle (T2) and at both ends (T1 and T3) of the gauge length, during the test. Thermocouples (type T, copper-constantan) were used with an accuracy better than $\pm 0.5^\circ\text{C}$.

The test tension was kept constant at 14.2 kN (corresponding to a tensile stress of 382 N/mm² or 30.0 % RTS) within $\pm 1.0\%$ by means of a constant tension device. The tension was measured with a calibrated load cell (accuracy < 0.5%) and continuously monitored during the test.

2.2. Start-end of test

The creep test was started on 11th April 2011, 10:30, and officially restarted on 28th April 2011, for another 1000 h. The creep test was officially terminated on 15th June 2011, 9:30, after 1560 h.

MOODY INTERNATIONAL
 Reviewed
 Witnessed
 Date: 28.04.2011

Заличено по чл. 36а, ал.3 от ЗОП

2.3. Results of the Creep Test

The temperatures T1, T2 and T3 were measured during the test time and yields the mean temperature $T_a = (T1+T2+T3)/3$. The minimum average temperature T_a during the test was 19.8 °C and the maximum average temperature was 21.8 °C. Figure 3 shows the temperatures during the test. The tension force during the test is shown in Figure 2.

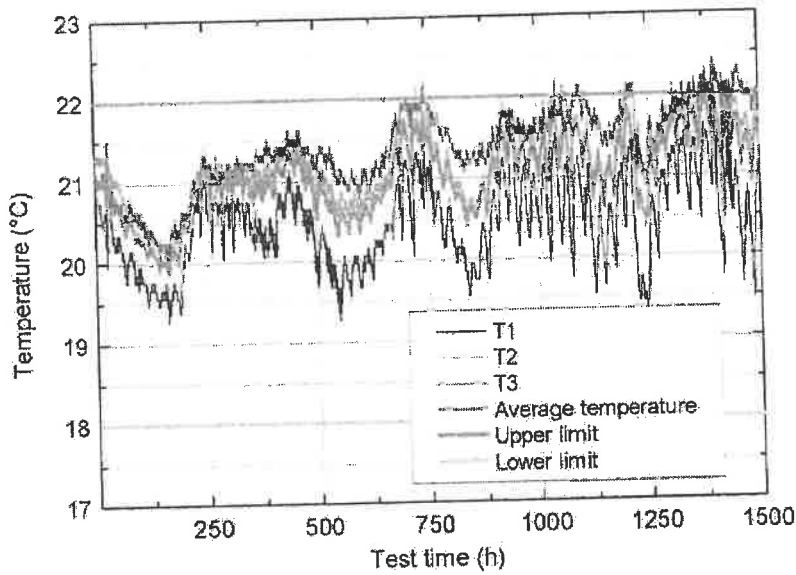

Figure 2: Measured temperatures during the test

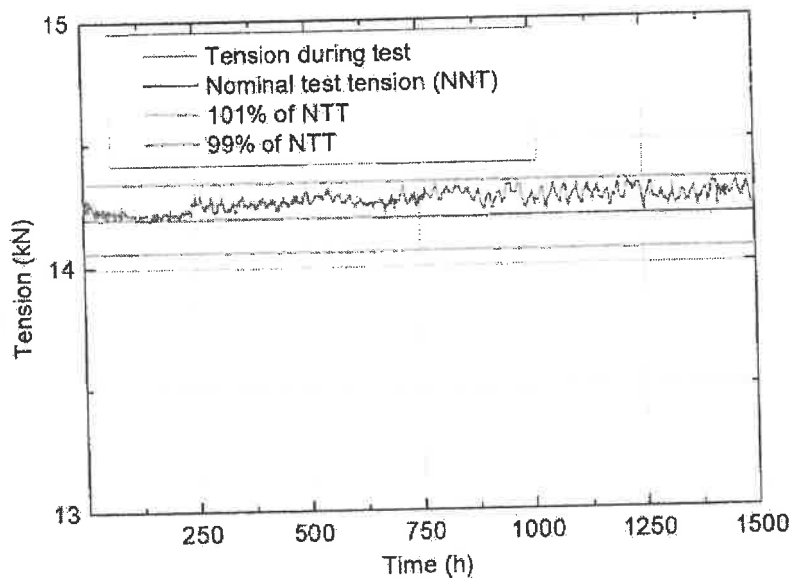

Figure 3: Tension during the creep test

VE-K 8786e

MOGDY INTERNATIONAL

Reviewed

Witnessed

Date: 28.04.2009

Заличено по чл. 36а,
ал.3 от ЗОП

3 Results

Table 1 gives the readings during the test. Temperature variations of strain were compensated by calculating the thermal strain variation $\epsilon_{\text{thermal}} = \alpha \cdot (\vartheta - \vartheta_0)$, where α is the coefficient of thermal elongation (13×10^{-6} 1/K as per data sheet), ϑ is the temperature at the time of data reading and ϑ_0 is the temperature at start of the measurement. The average of temperatures T_a was used. Creep strain ϵ_c was determined by subtracting thermal strain from measured total strain.

A linear regression was made using the values between 1 hour and 1000 hours to calculate the coefficients of the creep equation:

$$\epsilon_c = a \times t^b,$$

where ϵ_c is the creep strain in % and t is time in hours.

The following coefficients were determined:

$$a = 0.00703187$$

$$b = 0.158667$$

Calculated long time creep for 10 years (=87600 hours) is 0.0428%.

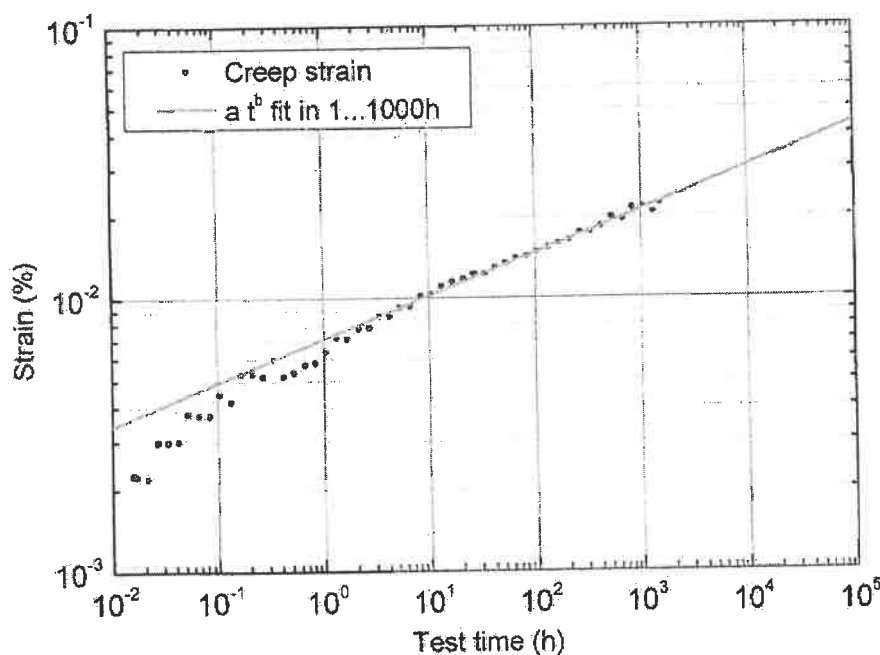

Figure 4: Measured creep strain and best fit straight line

MOODY INTERNATIONAL
 Reviewed
 Witnessed
 Date: 28.04.11
 15.08.11

Заличено по чл. 36а, ал.3 от ЗОП

Table 1: Readings of the Creep test

Time [h]	T1 [°C]	T2 [°C]	T3 [°C]	Ta [°C]	Total strain [%]	Thermal strain [%]	Creep strain [%]
0.016	20.4	20.9	20.3	20.7	0.00226	0	0.00226
0.016	20.4	20.9	20.3	20.7	0.00227	0	0.00227
0.016	20.4	20.9	20.3	20.7	0.00226	0	0.00226
0.017	20.4	20.9	20.4	20.7	0.00227	0.00003	0.00224
0.021	20.5	20.9	20.4	20.7	0.00226	0.00006	0.00219
0.026	20.5	20.9	20.4	20.7	0.00304	0.00006	0.00298
0.033	20.5	20.9	20.4	20.7	0.00304	0.00006	0.00298
0.042	20.5	20.9	20.4	20.7	0.00304	0.00003	0.00300
0.053	20.5	20.9	20.4	20.7	0.00381	0.00003	0.00378
0.066	20.5	21.0	20.4	20.8	0.00382	0.00010	0.00372
0.083	20.5	21.0	20.4	20.8	0.00382	0.00010	0.00372
0.105	20.5	20.9	20.5	20.8	0.00455	0.00010	0.00445
0.132	20.5	20.9	20.5	20.8	0.00436	0.00019	0.00417
0.166	20.5	21.0	20.5	20.8	0.00538	0.00010	0.00528
0.209	20.6	21.1	20.5	20.8	0.00539	0.00013	0.00526
0.264	20.6	21.1	20.6	20.9	0.00538	0.00023	0.00515
0.332	20.6	21.1	20.6	20.8	0.00615	0.00019	0.00596
0.418	20.6	21.1	20.6	20.9	0.00539	0.00023	0.00516
0.526	20.6	21.1	20.7	20.9	0.00559	0.00026	0.00533
0.662	20.6	21.0	20.7	20.9	0.00591	0.00023	0.00569
0.833	20.6	20.9	20.7	20.8	0.00593	0.00013	0.00580
1.049	20.6	20.9	20.7	20.8	0.00641	0.00010	0.00632
1.321	20.6	21.2	20.9	21.0	0.00750	0.00035	0.00715
1.663	20.8	21.2	20.8	21.0	0.00748	0.00039	0.00709
2.100	20.8	21.2	20.9	21.0	0.00814	0.00045	0.00769
2.650	20.8	21.3	20.8	21.0	0.00817	0.00042	0.00776
3.333	20.8	21.3	20.9	21.0	0.00900	0.00045	0.00855
4.183	20.8	21.2	21.0	21.0	0.00900	0.00045	0.00855
5.266	20.7	21.3	21.0	21.0	0.00962	0.00042	0.00920
6.633	20.7	21.3	20.9	21.0	0.00962	0.00039	0.00924
8.350	20.7	21.2	20.9	20.9	0.01043	0.00032	0.01011
10.500	20.7	21.3	21.0	21.0	0.01075	0.00042	0.01033
13.216	20.6	21.2	20.9	20.9	0.01133	0.00029	0.01104
16.633	20.5	21.2	21.0	20.9	0.01165	0.00023	0.01142
20.933	20.6	21.3	21.0	21.0	0.01210	0.00035	0.01174
26.590	20.8	21.1	21.0	21.0	0.01255	0.00035	0.01220
33.340	20.6	21.2	21.0	21.0	0.01256	0.00035	0.01221
41.840	20.2	20.9	20.7	20.6	0.01274	-0.00013	0.01287
52.590	20.4	20.9	20.7	20.6	0.01325	-0.00006	0.01331
66.340	19.8	20.7	20.6	20.3	0.01346	-0.00048	0.01394
83.340	20.0	20.6	20.6	20.4	0.01376	-0.00042	0.01417
105.090	19.8	20.5	20.5	20.2	0.01403	-0.00071	0.01474
132.090	19.7	20.3	20.4	20.0	0.01440	-0.00087	0.01527
166.340	19.5	20.3	20.3	19.9	0.01484	-0.00103	0.01588
209.340	20.1	20.6	20.6	20.4	0.01586	-0.00039	0.01624
263.590	20.6	21.0	21.0	20.8	0.01755	0.00019	0.01735
331.840	20.6	21.1	21.1	20.9	0.01773	0.00032	0.01741
417.840	20.6	21.2	21.3	21.0	0.01876	0.00045	0.01831

MOOD
 Revealed
 Witnessed
 Date 28.09.15
 № 1/30
 Заличено по чл. 36а,
 ал.3 от ЗОП

525.840	19.9	20.8	21.3	20.5	0.01948	-0.00019	0.01967
662.090	20.5	21.0	21.3	20.8	0.01958	0.00019	0.01938
833.340	19.8	20.6	21.0	20.4	0.02085	-0.00042	0.02127
1049.171	20.4	21.3	21.7	21.0	0.02202	0.00042	0.02160
1320.921	21.3	21.8	21.8	21.6	0.02192	0.00122	0.02069
1532.637	20.5	21.6	21.8	21.2	0.02273	0.00064	0.02209

M MOODY
INTERNATIONAL
 Reviewed
 Witnessed
Date: 28.04.11.06.11

Заличено по чл. 36а, ал.3 от ЗОП

3. Annex: Certificates

3.1. ISO 9001 certificate

CERTIFICATE TUV NORD

Management system as per
DIN EN ISO 9001 : 2008

It is certified, with TUV NORD CERT, that the following is in accordance with the

Richard Bergner Elektroarmaturen GmbH & Co. KG
Bahnhofstraße 8 - 10
91126 Schwabach
Germany

with the places
Schwabach and Radabof

Product: electrical systems for railway communication for the railway sector

Fittings and engineering services for electrical power industry;
catenary wire systems, telecommunication appliance and
substation clamps

Technical Progression No. 04 40 450 1 00
Last Approval: 2011-01-20

Version: 2011-07-01
Issue: 001/001

Заличено по чл. 36а, ал.3 от ЗОП

Richard Bergner
TUV NORD CERT GmbH

Logo: 2141-01-01

This certification is only valid if the certificate holder has accepted the conditions of the TUV NORD CERT website and has agreed to the terms and conditions of the contract.

TUV NORD CERT GmbH, Unter den Eichen 27, 10585 Berlin, Germany, www.tuv-nord.com



Заличено по чл. 36а, ал.3 от ЗОП

3.2. Load cell 100 kN

RIBE Richard Bergner Elektroarmaturen GmbH + Co. KG

EKL

Schwabach den 09.03.2011

Kalibrierschein nach DIN ISO 10012 Teil 1

Kalibrierscheinbezeichnung: Zer102_18 Seitenanzahl: 2
 Gültigkeitsdauer: 12 Monate

Die Kalibrierung wurde entsprechend der zugehörigen Arbeitsanweisung "Arb102_2" ausgeführt.

Gegenstand der Kalibrierung:

Seilzugkraftmeßkette des Prüfstandes Spur 3 im Innenraumschwingungsstand, bestehend aus:

Geräte:	Zugkraftaufnehm.;	Meßverstärker;
Type:	K 11;	PAX S;
Hersteller:	LORENZ;	LORENZ;
Seriennr.:	48070;	7524;
Sonstiges:		Kalibrierwert- anzeige

Referenzmeßkette:

Geräte:	Kraftaufnehmer;	Meßverstärker;
Type:	U2A (XM001);	MC55 (AB12);
Hersteller:	HBM;	HBM;
Seriennr.:	F 18511;	ohne;
Genauigkeitskl.:	0.1;	Referenzwert- anzeige

Einzelheiten der Referenzmeßkette sind im gültigen Kalibrierschein Nr.: FL885 HBM 2009-09 der Firma HBM vom 2009-09-07 beschrieben, die Kalibrierung ist im Sinne der DIN EN ISO 9001 und DIN ISO 10012, Teil 1 auf nationale Normale rückführbar.

Meßwerte: siehe Rückseite

Prüfdatum: 09.03.2011

Prüfer: Jung / Heini

Unterschrift:

Заличено по чл. 36а,
ал.3 от ЗОП

MOODY
INTERNATIONAL

Reviewed
 Witnessed
 Date: 15.06.11

Заличено по чл. 36а,
ал.3 от ЗОП

3.3. Displacement sensors

Kalibrierschein nach DIN ISO 10012 Teil 1

Kalibrierscheinbezeichnung: Zert125_18 **Seitenanzahl:** 3
Gültigkeitsdauer: 12 Monate

Die Kalibrierung wurde entsprechend der Arbeitsanweisung " 125/1 " durchgeführt.

Gegenstand der Kalibrierung: Beide Wegtaster für getrennte Wegmessungen,
Taster B mit 25[m] Verlängerungskabel.

Meßkette für Kriechdehnungsmessungen an Seilen und Kabeln bis 200[kN], bestehend aus:

Geräte:	Wegtaster A	Wegtaster B	Verstärker
Type:	WA 50 mm	WA 20 mm	SPIDER
Hersteller:	HBM	HBM	HBM
Seriennr.:	82810077	40710321	-
Genauigkeitskl.:	0,1	0,1	0,1
Sonstiges:	6-Leiter	6-Leiter	

Referenzmaße:

Geräte:	Endmaßsatz	Haltevorrichtung
Type:	-	-
Hersteller:	C.Johansson	RIBE
Seriennr.:	11	-
Genauigkeitskl.:	1 bei 20°	-
Sonstiges:	DKD - 17301	-

Einzelheiten der Referenzendmaße sind im gültigen Kalibrierschein vom 21.6.2005 beschrieben. Die Kalibrierung ist im Sinne der DIN EN ISO9001 und DIN ISO 10012, Teil 1 auf nationale Normale rückführbar.

Meßwerte: siehe Rückseite

Prüfdatum: 21.03.2011

Prüfer: Jung / Heini

Unterschrift:

Заличено по чл. 36а,
ал.3 от ЗОП

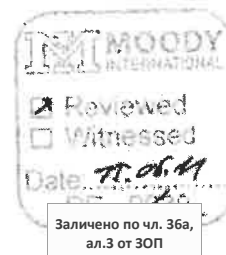

Richard Bergner Elektroarmaturen GmbH & Co. KG is certified by TÜV NORD CERT GmbH in accordance with DIN EN ISO 9001:2008, certificate registration No. 04 100 950 150.

A quality management system in accordance with DIN EN ISO 9001 ensures a continuous inspection of measuring and test equipment. Reference standards traceable to national standards are available.

Richard Bergner Elektroarmaturen GmbH & Co. KG is a certified supplier of the Chinese „Ministry of Railways“ (MoR).

Richard Bergner Elektroarmaturen GmbH & Co. KG is an authorized supplier by Sellihca Nordic Utility Pre-Qualification System with registration No.101109.

Richard Bergner Elektroarmaturen GmbH & Co. KG is an authorized supplier of ADWEA, PCGIL and ESKOM.

Richard Bergner Elektroarmaturen GmbH & Co. KG is an authorized supplier of E.ON AG, RWE AG and Vattenfall Europe AG for high voltage OHTL fittings, fittings for fibre optic cables and for damping systems.

Richard Bergner Elektroarmaturen GmbH & Co. KG is an authorized supplier of Deutsche Bahn AG, Nederlandse Spoorwegen and Österreichischen Bundesbahnen AG.

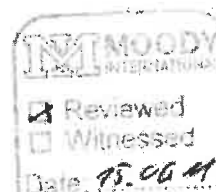

Заличено по чл. 36а, ал.3 от ЗОП



AFL Telecommunications GmbH

Type Test Report

No. TB 2118/11
Date: 05.05.2011
Page: 22

Salt Spray (Corrosion resistant) Test

Annex 12

Cable type: ASLH-D(S)B 36 SMF (A20SA 37 – 2,9)
Cable product spec.: TK 10471/10-03
Cable-ID: 10283527/6735
Test procedure: EIA/TIA-455-16A

Test conditions: duration: min. 1000h
temperature: 35°C
salt concentration: 5%

Results: see report of independent laboratory

RIBE

RIBE ELEKTROARMATUREN

Schwabach - Radebeul

Schwabach, 28 April 2011

PROTOCOL

Termination of test on OPGW

At the request of: **AFL Telecommunications GmbH**
Project: **Saudi Electricity Company SEC**
Saudi Arabia

The following test:

Test	OPGW
Salt Spray (Corrosion) Test	ASLH-D(S)b 36 SMF (A20SA 37 - 2,9)

was inspected in the presence of the persons named below. New samples were put into the salt spray chamber and the test will run another 1000 h.

The test procedure was found to be in order. The test results will be documented in final detailed reports.

Mr Saeed Hamad Al Kahtani / SEC
Mr Majid Abdurahman Al Suhibani /
Mr Abdulaziz Abdurahman Al Hagba
Mr Norbert Zimmermann / Moody
Mr Heribert Mühlen / AFL
Mr Carl-Magnus Kyrklund / AFL

**Заличено по чл. 36а,
ал.3 от 30П**

Dr. Mario Dansachmüller / RIBE

Заличено по чл. 36а, ал.3 от 30П

Annexes

Annex 1	Salt Spray (Corrosion resistant) Test	2
Annex 2	ISO 9001 Certificate.....	3
Annex 3	Tensile test machine 40 kN.....	4

Protocol

Annex 1 Salt Spray (Corrosion resistant) Test

Test standard: EIA/TIA-455-16A, "FOTP-16 - Salt Spray (Corrosion resistant) Test for Fiber Optic Components"

Measurement devices: Tensile test machine 40 kN (calibration certificate see Annex 3)

Test requirements: No significant corrosive action,
no significant degradation of tensile strength of wires.



Handwritten mark resembling the letter 'P'.

Protocol

Annex 2 ISO 9001 Certificate

CERTIFICATE TUV NORD

Management system as per
DIN EN ISO 9001 : 2008

In accordance with TUV NORD CERT procedures, it is hereby certified that

Richard Bergner Elektroarmaturen GmbH & Co. KG
Bahnhofstraße 8 - 16
91126 Schwabach
Germany

with the places
Schwabach and Radebeul

in place with management system and with the above conditions for the following scope

**Fittings and engineering services for electrical power industry,
catenary wire systems, telecommunication appliance and
substation clamps**

Certificate Registration No. 04 113 900150
Audit Report No. 0304 1010

Valid until 2012-07-29
Expiration Condition 100%

Заличено по чл. 36а, ал.3 от ЗОП

Handwritten signature
Certification Body
d. TUV NORD CERT GmbH

Revision: 2009-07-00

This certification was conducted in accordance with the TUV NORD CERT auditing procedures and is subject to regular surveillance audits.

TUV NORD CERT GmbH

Registered address:

10115 Berlin

www.tuv-nord.com



Large handwritten signature on the left side of the page.

Large handwritten mark resembling a 'J' on the right side of the page.

RIBE ELEKTROARMATUREN

Schwabach - Radebeul

Test Report

K 8766e

Title: Salt Spray (Corrosion) Test
on Optical Ground Wire ASLH-D(S)b 36 SMF
(A20SA 37 – 2,9) - dia. 8,6 mm
manufactured by AFL Telecommunications

File:
1.8

At the request of: AFL Telecommunications GmbH
Test standard: EIA/TIA-455-16A, "FOTP-16 - Salt Spray (Corrosion) Test for Fiber Optic Components"
Contents: 10 pages

Summary:

A Salt Spray (Corrosion) Test according to EIA/TIA-455-16A was carried out on samples of OPGW:

ASLH-D(S)b 36 SMF (A20SA 37 – 2,9) - dia. 8,6 mm

For details of OPGW see Appendix 1. The length of the specimens was 800 mm. Purpose of the test was to determine the effects of a controlled salt-laden atmosphere on the fiber optic cable.

Result:

Condition of the ACS wires: There were no signs of ferrous rust visible. After the test the mechanical strength of the wires was as specified.

The requirements were fulfilled.

Заличено по чл. 36а, ал.3 от ЗОП

Stefan Halbig
Development Engineer

Schwabach, 15th June, 2011

Mario Dansachmüller
Test Engineer

Reviewed
 Witnessed
Date: 29.06.11
DE - 0037

Заличено по чл. 36а,
ал.3 от ЗОП

VB

Accreditation:

Das Qualitätsmanagementsystem der Richard Bergner Elektroarmaturen GmbH & Co. KG ist vom TÜV NORD CERT GmbH in Übereinstimmung mit DIN EN ISO 9001:2008 mit der Zertifikat-Registrier-Nummer 04 100 950 150 zertifiziert.

Adresses:

Manufacturer: AFL Telecommunications GmbH
Bonnenbroicher Str. 2-14
41238 Mönchengladbach, Germany

At the request of: AFL Telecommunications GmbH
Bonnenbroicher Str. 2-14
41238 Mönchengladbach, Germany

Test laboratory: RIBE Test Laboratory
Werk 2
Industriestr. 4
91126 Schwabach, Germany



Заличено по чл. 36а, ал.3 от ЗОП

J

Contents

	Page
1. Drawing of test sample	4
2. Test set-up and procedure	5
3. Test results	5
4. Annex: Certificates	8
4.1. ISO 9001 certificate	8
4.2. Tensile test machine 40 kN	9

This report consists of
Pages (in total)

10

M MOODY
INTERNATIONAL

Reviewed
 Witnessed

Date: 28.04.15. CR-01

Заличено по чл. 36а,
ал.3 от ЗОП

1. Drawing of test sample



18.10.2010, WS.
120128200300-954216725 TK 10471710-03

ASLH-D(S)B 36 SMF (A20SA 37 - 2.9)

Optical Ground Wire (OPGW) according to EN 60794-4 standards

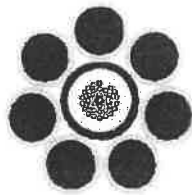

- Stranding direction of outer layer: right hand (Z-stranding)
- Wires acc. to EN 61232
- Maximum fibre capacity per steel tube: 36
- Fibres coloured acc. to colour code system 036 F SEC
- Fibres acc. to G.852
- Impregnated wooden drum with protection

Configuration

Center	1 Stainless Steel Tube with 36 SMF <i>Stainless steel tube material: DIN EN 10088-02, Mat. No. 1.4404</i>	2,90 / 3,40 mm
Layer 1	7 A20SA - Wires	2,60 mm

Mechanical Data

Cable Diameter	8,6 mm
Cable Weight	275 kg/km
Supporting Cross Section	37,2 mm ²
Rated Tensile Strength (RTS)	47,3 kN
Ratio RTS / Cable Weight	17,5 km
Modulus of Elasticity	162,0 kN/mm ²
Thermal Elongation Coefficient	13,0 10 ⁻⁶ /K
Permissible Maximum Working Stress (42% RTS)	534,7 N/mm ² (19,9kN)
Recommended Everyday Stress (16% RTS)	203,7 N/mm ² (7,6kN)
Ultimate Exceptional Stress (72% RTS)	916,6 N/mm ² (34,1kN)

Electrical Data

DC Resistance (20°C)	2,325 Ω/km
Conductivity	20,0% IACS
Short Time Current (1,0s, 50-200°C)	2,9 kA
Short Time Current (0,3s, 50-200°C)	5,3 kA
Short Time Current Capacity Pt (50-200°C)	8,3 kA ² s

Application

Maximum Permissible Installation Force	14,2 kN
Minimum Bending Radius	108 mm
Normal Delivery Length	129 mm
Temperature Range Installation	4000 m
Transportation and Operation	-10 to +50°C
	-40 to +80°C

MOODY
INTERNATIONAL

Reviewed
X Witnessed
Date: 28.04.11, 06:41

Заличено по чл. 36а,
ал.3 от ЗОП



2. Test set-up and procedure

A salt spray chamber SSC 1000 manufactured by Weiss/Germany was used to create and maintain the salt spray (fog) test environment in accordance with EIA/TIA-455-16A.

A tensile test was carried out on the individual wires of a cable sample to establish their initial tensile strength.

Another sample of cable (approx. length 0.8 m) was placed in the salt spray chamber with a 15° inclination of its longitudinal axis to vertical. It was exposed to a salt spray (fog) environment for 1000 hours at 35°C ±1°C (test terminated on June 15th, 2011, 11:00). The salt-solution concentration was 5 %. It was prepared by dissolving 5 parts (by weight) of sodium chloride in 95 parts (by weight) of distilled water. The pH-value of the solution was maintained between 6.5 and 7.2, when measured at a temperature of 35±2°C.

3. Test results

On completion of the Salt Spray Test, the surface condition of the exposed wires of the cable sample was visually examined and photographed.

The surface of the ACS wires of the cable outer layer showed a dull appearance. The grease layer around the stainless steel tube containing the optical fibers was intact. After cleaning the stainless steel tube showed no signs of corrosion.

The individual ACS wires were then subjected to a tensile test to establish their tensile strength after the Salt Spray Test. A calibrated tensile test machine was used.

Tensile strength of wires, cable specimen not subjected to salt spray test

Wire	Wire material	Wire diameter mm	Tensile breaking load kN	Tensile breaking stress MPa	Min. tensile breaking stress after stranding acc. to IEC 61232 MPa
1st layer					
1	ACS	2.59	8.25	1565.90	1273
2	ACS	2.59	8.5	1613.35	1273
3	ACS	2.59	8.15	1546.92	1273
4	ACS	2.59	8.3	1575.39	1273
5	ACS	2.59	8.25	1565.90	1273
6	ACS	2.59	8.45	1603.86	1273
7	ACS	2.59	8.05	1527.94	1273
Average:				1571.32	

MOODY
INTERNATIONAL

Reviewed

Witnessed

Date: **28.04.11.06.01**

Заличено по чл. 36а,
ал.3 от ЗОП

Tensile strength of wires after salt spray test

Wire	Wire material	Wire diameter mm	Tensile breaking load kN	Tensile breaking stress MPa	Min. tensile breaking stress after stranding acc. to IEC-61232 MPa
1st layer					
1	ACS	2.59	8.35	1584.88	1273
2	ACS	2.59	8.2	1556.41	1273
3	ACS	2.59	8.3	1575.39	1273
4	ACS	2.59	8.4	1594.37	1273
5	ACS	2.59	8.25	1565.90	1273
6	ACS	2.59	8.5	1613.35	1273
7	ACS	2.59	8.4	1594.37	1273
Average:				1583.53	

No significant change of tensile strength of wires.

Reviewed

 Witnessed

 Date: 28.04.15 06.41

 DE - 0038

Заличено по чл. 36а, ал.3 от ЗОП

Photographs:

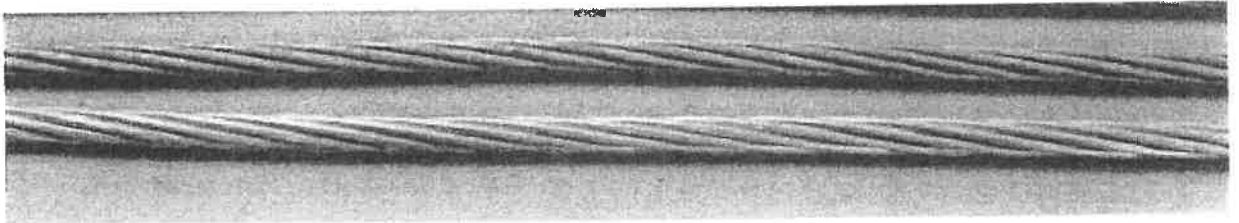

Fig. 1: Bottom cable specimen, no exposure to salt spray, Top cable specimen after test and rinsing with clear water.

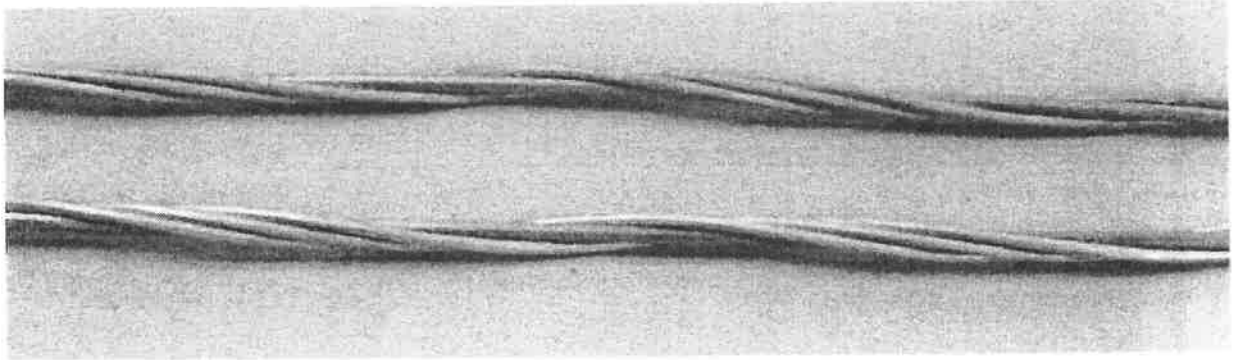

Fig. 2: Four wires of outer wire layer unwrapped. View of stainless steel tube. Bottom cable specimen, no exposure to salt spray. Top cable specimen after test.

MOODY INTERNATIONAL
 Reviewed
 Witnessed
Date: 28.04.2021
05:00

Заличено по чл. 36а, ал.3 от ЗОП

4.2. Tensile test machine 40 kN



Zentrum für Konstruktionswerkstoffe
Staatliche Materialprüfungsanstalt Darmstadt
Fachgebiet und Institut für Werkstoffkunde
Prof. Dr.-Ing. C. Berger



TECHNISCHE
UNIVERSITÄT
DARMSTADT

Prüfzeugnis W 091797.2

über die Prüfung einer Werkstoffprüfmaschine nach DIN 51220

1. Ausfertigung

Auftraggeber: RIBE, Richard Bergner Elektroarmaturen GmbH & Co. KG
Bahnhofstraße 8 - 16
91126 Schwabach

Bestell - Nr.: 91905 vom 30.11.09 Vertrag Nr.: W 620

Aufstellungsort: Werk II, Elektroarmaturen, Versuch und Entwicklung Abt. EE, Industriestraße

Bauart/Typ: 40 kN Zugprüfmaschine / UHP4

Hersteller: Losenhausen Maschinenbau AG, Düsseldorf Herstell - Nr.: 23218

Baujahr: 1970 Inv. -Nr.: 17-01-60

Beanspruchungseinrichtung: Hydraulisch

Messeinrichtung: Pendelmanometer,

Anzeigebereiche: 2/4/8/20/40 kN Prüftemperatur: 21 °C

Masse der Pendelscheiben: A = 15,175 kg; B = 12,090 kg;
C = 3,025 kg

Datum der Prüfung: 17.12.2009 Prüfer: Dipl.-Ing. V. Marzian

1 Prüfergebnis

Die Prüfung erfolgte nach DIN EN ISO 7500-1 und Beiblatt 1. Die Prüfmaschine entspricht dieser Norm bei zu- und abnehmender Prüfkraft und kann

Im Anzeigebereich	von	bis	In der Klasse	Bemerkungen s. Abschnitt 3.2
40 kN Druck	4 kN	40 kN	1	
20 kN Druck	2 kN	20 kN	1	
	4 kN	20 kN	0,5	
8 kN Druck	0,8 kN	8 kN	1	
4 kN Druck	0,4 kN	4 kN	1	

für maßgebliche Versuche mit und ohne Benutzung des Schleppzeigers als Zusatzmesseinrichtung verwendet werden.

Staatliche Materialprüfungsanstalt Darmstadt
Kompetenzbereich Mess- und Kalibriertechnik
Grafenstraße 2, 64283 Darmstadt

Seiten: 6
Tabellen: 5
Bilder: ---
Anlagen: ---

Berichtsdatum: 21. Dezember 2009 Zeichen: W/Ma

Die Leitung

i.A. *R. Tscheuschner*

Prof. Dr.-Ing. R. Tscheuschner

Der Sachbearbeiter

Marzian

Dipl.-Ing. V. Marzian

Заличено по чл. 36а, ал.3 от ЗОП



Заличено по чл. 36а,
ал.3 от ЗОП



Akkreditiert nach DIN EN ISO/IEC 17025.
Die Akkreditierung umfasst die in der Akkreditierungsurkunde
aufgeführten Prüfbereiche und Prüfverfahren

Richard Bergner Elektroarmaturen GmbH & Co. KG ist vom TÜV NORD CERT GmbH in Übereinstimmung mit DIN EN ISO 9001:2008 mit der Zertifikat-Registrier-Nummer 04 100 950 150 zertifiziert.

A quality management system in accordance with DIN EN ISO 9001 ensures a continuous inspection of measuring and test equipment. Reference standards traceable to national standards are available.

Richard Bergner Elektroarmaturen GmbH & Co. KG is a certified supplier of the Chinese „Ministry of Railways“ (MoR).

Richard Bergner Elektroarmaturen GmbH & Co. KG is an authorized supplier by Sellihca Nordic Utility Pre-Qualification System with registration No.101109.

Richard Bergner Elektroarmaturen GmbH & Co. KG is an authorized supplier of ADWEA, PCGIL and ESKOM.

Richard Bergner Elektroarmaturen GmbH & Co. KG is an authorized supplier of E.ON AG, RWE AG and Vattenfall Europe AG for high voltage OHTL fittings, fittings for fibre optic cables and for damping systems.

Richard Bergner Elektroarmaturen GmbH & Co. KG is an authorized supplier of Deutsche Bahn AG, Nederlandse Spoorwegen and Österreichischen Bundesbahnen AG.



Заличено по чл. 36а, ал.3 от ЗОП

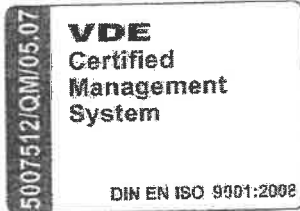

RWE Eurotest GmbH Electrotechnical Testing Laboratory



Test report

No.: 12_186-2

Version: 2/2

Customer : AFL Telecommunications GmbH
Bonnenbroicher Straße 2-14
41048 Mönchengladbach

Test object : Optical Ground Wire (OPGW)

Type : ASLH-D(S)b 48 SMF (27SA 75 - 10,0)

Manufacturer : AFL Telecommunications GmbH

Date of receipt : 11.06.2012

Date of test : 20.06.2012 - 22.06.2012

Applied test regulations : According to Terna-standard UX LC3907 in consideration of IEC 60794-4-1

Test carried out : - Short circuit test ($I^2t = 50 \text{ kA}^2\text{s}$), Terna Test-No.: S
- Lightning test ($Q = 100 \text{ As}$), Terna Test-No.: BB

Test result : The OPGW, type ASLH-D(S)b 48 SMF (27SA 75 - 10,0) manufactured by AFL Telecommunications GmbH passed the short circuit test and lightning test according to Terna-standard UX LC3907.

Specialist testers : C. Pieper, H. Walter

Dortmund, 18.07.2012

H. Walter
Test engineer

A. Schlüter
Test engineer

Заличено по чл. 36а, ал.3 от ЗОП

Report No. 12_186-2 contains 12 pages and 5 annexes.

Test results in this report are only valid for the tested objects. A partly duplication or publication is not allowed without written permission by RWE Eurotest. The authenticity of this report is only ensured with RWE-coinage on the first page.

Summary

RWE Eurotest GmbH carried out a short circuit test and a lightning test according to Terna-standard UX LC3907 on an OPGW manufactured by AFL Telecommunications GmbH, type ASLH-D(S)b 48 SMF (27SA 75 - 10,0). The optical attenuation of the optical fibres was measured by the manufacturer during the tests. The recording of this measurement was carried out by RWE Eurotest.

The tests were witnessed by the following persons:

T. Mongelli (IMQ), U. Jansen (AFL Telecommunications GmbH)

Result of tests:

The OPGW, type ASLH-D(S)b 48 SMF (27SA 75 - 10,0) manufactured by AFL Telecommunications GmbH passed the short circuit test and lightning test according to Terna-standard UX LC3907.

Contents:	Page:
1. Applied test regulations	4
2. Technical data of the test object	4
3. Test and measuring equipment	5
4. Tests carried out and results	6

Annex:

01 Temperature-, attenuation-, short circuit current-, tensile load/time diagrams	(15 pages)
02 Arc current-, optical attenuation-, tensile load/time diagrams and photos of the wire damages of the test object	(18 pages)
03 Data sheet of the OPGW	(1 page)
04 Tensile test report	(2 pages)
05 Certificates of calibration of the test equipment of RWE Eurotest	(6 pages)

1. Applied test regulations

According to Terna standard

UX LC3907;Rev.00

Rules regarding the construction and testing of optical fiber shield wires

2. Technical data of the test object

ASLH-D(S)b 48 SMF (27SA 75 - 10,0)	
Cable Diameter	12.0 mm
Supporting Cross Section	75.4 mm ²
Rated Tensile Strength (RTS)	74.5 kN
Nominal Short Circuit Rating	10 kA; 0.5 s ($I^2t = 50.0 \text{ kA}^2\text{s}$)

Table 1: Technical data of the test object (for details see annex 03)

3. Test and measuring equipment

Equip.-No.	cal.	Equipment	Type	Manufacturer
ET-505	*	Impulse current sensing resistor	ISM 250 P	Hilo Test
ET-506	*	Impulse current sensing resistor	ISM 250 P	Hilo Test
ET-507	*	Impulse current sensing resistor	ISM 250 P	Hilo Test
ET-533		50 kA high-current test equipment	GDPN 5000/12 Sp	Siemens
ET-651	*	ScopeCorder	DL750	YOKOGAWA
ET-770	*	Load cell	U2A 5t	HBM
ET-811	*	Fibre Optic Isolated Digitizing Subsystem	GEN7t	HBM
01-120	1)	Optical Power Meter	ML 910 B	Anritsu
01-105	1)	Optical Power Meter	MA 9301A	Anritsu
01-101	1)	Stabilized Light Source	MG 9002 A	Anritsu
-		Edge-Emitting LED Source	MG 0918 D	Anritsu
-		Switch	-	AFL
-	*	Thermocouples 0.5 mm	NiCr-Ni	Rössel

*) Measuring equipment is calibrated based on national and international reference standards. Calibration certificates can be inspected on request.

1) Measuring equipment of AFL is calibrated based on national and international reference standards.

Table 1: Test and measuring equipment

The measurement uncertainty of the measuring instruments has been calculated and is archived by RWE Eurotest. Documents can be inspected on request.